

LABORATORY TESTS WITH QUALITY DATA IN DENTISTRY

ABSTRACT

In laboratory tests, just following the manufacturer's instructions of materials or equipments may not be enough to obtain reliable data. Thus, intra and inter-examiners studies may be required. The aim of this study was to illustrate the application of the Intraclass Correlation Coefficient (ρ) in a study related to the color changing and hardness of composite resin conducted by two examiners. The color and hardness of 10 specimens of composite resin were evaluated by a colorimetric spectrophotometer and hardness tester, respectively, at two different times. Two trained examiners performed two measurements with an interval of one week. Specimens were stored in artificial saliva at $37\pm 1^{\circ}\text{C}$ for 7 days. The Intraclass Correlation was used for analysis of intra and inter-examiner reproducibility. The intra-examiner reproducibility was 0.79, 0.44 and 0.76 for L, a and b color coordinates for the examiner 1 and 0.84, 0.23, 0.21 for examiner 2. For hardness, ρ -values were 0.00 and 0.23 for the examiner 1 and 2, respectively, showing unsatisfactory agreement on color and hardness evaluation for both examiners. It was noted that only the observation of protocol for use of equipment and examiners training were not sufficient to collect reliable information. Thus, adjustments in the experimental protocol were made and devices were produced to standardize the measurements. The reproducibility study was performed again. For examiner 1, values as 0.90, 0.59 and 0.79 were verified for L, a and b coordinates and, for examiner 2 were obtained values of 0.90, 0.75, 0.95. In relation to hardness, ρ -values of 0.75 and 0.71 were obtained for examiners 1 and 2, respectively. The inter-examiner reproducibility was 0.86, 0.87, 0.91 for L, a and b coordinates and 0.79 for hardness. It was concluded that intra and inter-examiner calibration is essential for obtaining quality measurements in laboratory tests.

CAMPOS, Juliana Alvares Duarte Bonini*
OLIVEIRA, Ana Luísa Botta Martins**
DOMINGOS, Patrícia Aleixo dos Santos***
BOTTA, Ana Carolina****
GARCIA, Patrícia Petromilli Nordi Sasso*****

KEYWORDS

Reproducibility of results. Laboratory research. Dentistry.

Department of Social Dentistry, Araraquara School of Dentistry, University of São Paulo State, Araraquara, São Paulo, Brazil*

Department of Pediatric and Social Dentistry, Juiz de Fora Federal University, Juiz de Fora, Minas Gerais, Brazil**

Department of Dentistry, University Center of Araraquara, UNIARA, Araraquara, São Paulo, Brazil***

Department of General Dentistry, Stony Brook University, New York, USA****

Department of Social Dentistry, Araraquara School of Dentistry, University of São Paulo State, Araraquara, São Paulo, Brazil*****

INTRODUCTION

Laboratory tests are commonly performed prior to epidemiological and clinical studies in Dentistry. Usually researchers are trained to develop the methodology according to manufacturer's instructions of each material or equipment to be used. However, only the training may not be sufficient to obtain reliable values, since measurements can be performed by one or more examiner at different times and they are subject to errors. So for that reliability is maintained, intra and inter-examiners studies are required, which will demonstrate the examiners calibration.

Although important, it is not usual to carry out calibration prior to laboratory tests, what should cause concern about the quality of the information collected. Studies of data reliability should be performed for calibration.

The level of measurement of study variables must be defined to determine the statistical method that will calculate the reproducibility. If the variables are qualitative, the Kappa statistic (κ) should be used. Furthermore, if these variables are ordinal, the weighting is indicated.¹ For quantitative variables, the intraclass correlation coefficient is the recommended statistical test.¹⁻⁵

This study was conducted in order to alert the dental researchers on the importance of obtaining quality data and emphasize the necessity of intra and inter-examiner calibration, prior to execution of laboratory

tests. Therefore, the aim of this study was to illustrate the application of the Intraclass Correlation Coefficient (ICC) (ρ) in a pilot study related to the color changing and hardness of composite resin conducted by two examiners.

MATERIAL AND METHODS

Ten specimens were prepared with a composite resin (Filtek Supreme XT, shade B1E, 3M ESPE, Saint Paul, MN, USA) in stainless steel bipartite matrix with two circular orifices of 11 mm of diameter and 2 mm of thickness.⁶⁻⁹ During their manufacturing, all the specimens were notched on their reverse side to serve as an orientation for the hardness measurements.⁸ Specimens were immersed in artificial saliva and stored at $37 \pm 1^\circ\text{C}$ for 7 days.

The color was assessed with a spectrophotometer (Color guide 45/0, PCB 6807 BYK-Gardner GmbH Geretsried, Germany) using the CIELab system, according to manufacturer's instructions. After calibration, the specimen was positioned on a white tile and a transparent acrylic plate of 15 cm long, 7 cm wide and 2 mm thick with center hole 10 mm in diameter to standardize the color analysis (Figure 1). The color analysis was initiated with the touch of the button operation of the device, which emitted a signal when the data was obtained.

The hardness was assessed using a digital hardness tester (Buehler – Lake Bluff, Illinois, USA) with a Vicker diamond tip, which was applied to specimens for 30 seconds with a load of 50gf.⁹ This procedure was performed in three different areas, obtaining three values, which resulted in a final average for each specimen. Hardness procedures

were accomplished using a standardized device to guarantee the specimen's correct position. The specimens were positioned in the device so that the central groove on its back was coincident with the center line drawn on the device (Figure 2).

It is important to clarify that the color and hardness analyses are commonly used in Dentistry and for this reason they were chosen to exemplify the intra and inter-examiner calibration technique.

Two trained examiners performed two measurements of color and hardness with an interval of one week, following manufacturer's instructions of each equipment.

The intra and inter-examiner reproducibility was evaluated by the Intraclass Correlation Coefficient (ρ)^{3,4} and the level of agreement was classified according to Fermanian (1984)² (Table 1).

Figure 1 - Device used to position the specimen and color measurements with spectrophotometer.

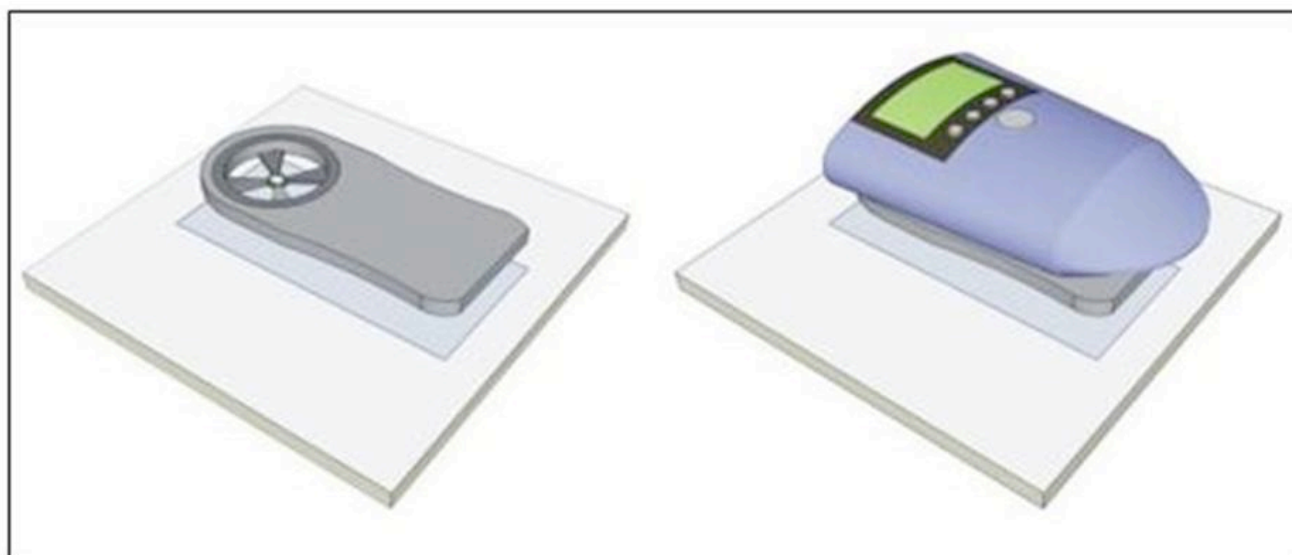

Figure 2 - Standardized device used to guarantee the specimen's correct position for hardness analysis.

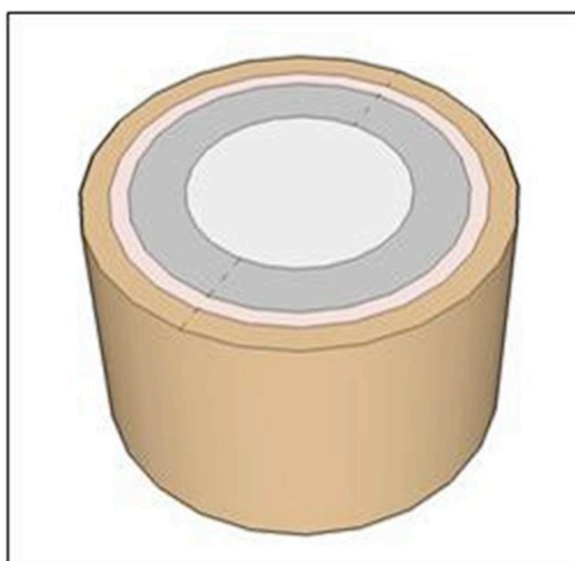

Table 1 - Level of agreement according to Fermanian² (1984).

Level of agrément	ρ
Very good	≥ 0.91
Good	0.90 - 0.71
Moderate	0.70 - 0.51
Poor	0.51 - 0.31
Very bad	< 0.31

In this study, it was considered appropriate the level of agreement at least classified as good because many of interfering factors can be controlled.

The dispersion graphic was used to organize the data because it is the most adequate representation, according to Bulman and Osborn (1989)¹⁰. The perfect agreement occurs when the points are distributed in the equality line ($y=x$).

RESULTS

Table 2 displays the intra and inter-examiner reproducibility on color changing and hardness.

It was verified that only for the L* coordinate the ρ value was classified as good for both examiners.

Values obtained for color changing (coordinates L*, a*, b*) and hardness by examiner 1 and 2 are represented in Figure 3 and Figure 4, respectively.

These results were surprising, since it was thought that by using a spectrophotometer that got the color measurements automatically, without interference from the researcher, the results would be reproducible. It was questioned what could be

interfering the reproducibility, since all the manufacturer's instructions had been followed and the examiners had been trained.

It was believed that the transparent acrylic plate used could be suffering color influence from the environment. Thus, it was replaced by a white acrylic plate with the same measures as the other one (Figure 5). Another issue considered was the possible interference of time and environment on data, since the brightness could be changed. Therefore, in order to standardize the brightness, it was decided to perform the color analysis in the same time and environment.

The hardness analysis was standardized by setting specific coordinates on the north-south and east-west axes of hardness tester to obtain measurements in three different areas of the specimen. Thirteen east / west (a), 16 north / south (b) and 10 north / south (c) coordinates oriented the first, second and third measurements, respectively (Figure 6).

After these adjustments, the analyses were repeated in the same way as previously presented.

Table 3 shows the intra and inter-examiner reproducibility on color changing and hardness, after adaptation of the methodology.

It was possible to verify that the methodological changes were appropriate because the inter-examiner reproducibility of the

coordinates L^* , a^* and hardness were classified as "Good" and the coordinate b^* as "Very good". Examiner 2's level of agreement was considered appropriate in all the measurements performed.

Compared to the first test, examiner 1's level of agreement was improved significantly.

Table 2 - Intra and inter-examiner reproducibility on color changing (coordinates: L^* - luminosity, a^* - chromaticity red-green axis, b^* - chromaticity yellow-blue axis) and hardness.

	(Classification)		
	Examiner 1	Examiner 2	Examiner 1 X 2
L^*	0.7878 (Good)	0.8396 (Good)	0.8386 (Good)
a^*	0.4390 (Poor)	0.2261 (Very bad)	0.5967 (Moderate)
b^*	0.7557 (Good)	0.2077 (Very bad)	0.8428 (Good)
Hardness	0.0031 (Very bad)	0.2340 (Very bad)	0.3849 (Poor)

Figure 3 - Values obtained for color changing (coordinates L^* , a^* , b^*) and hardness by examiner 1.

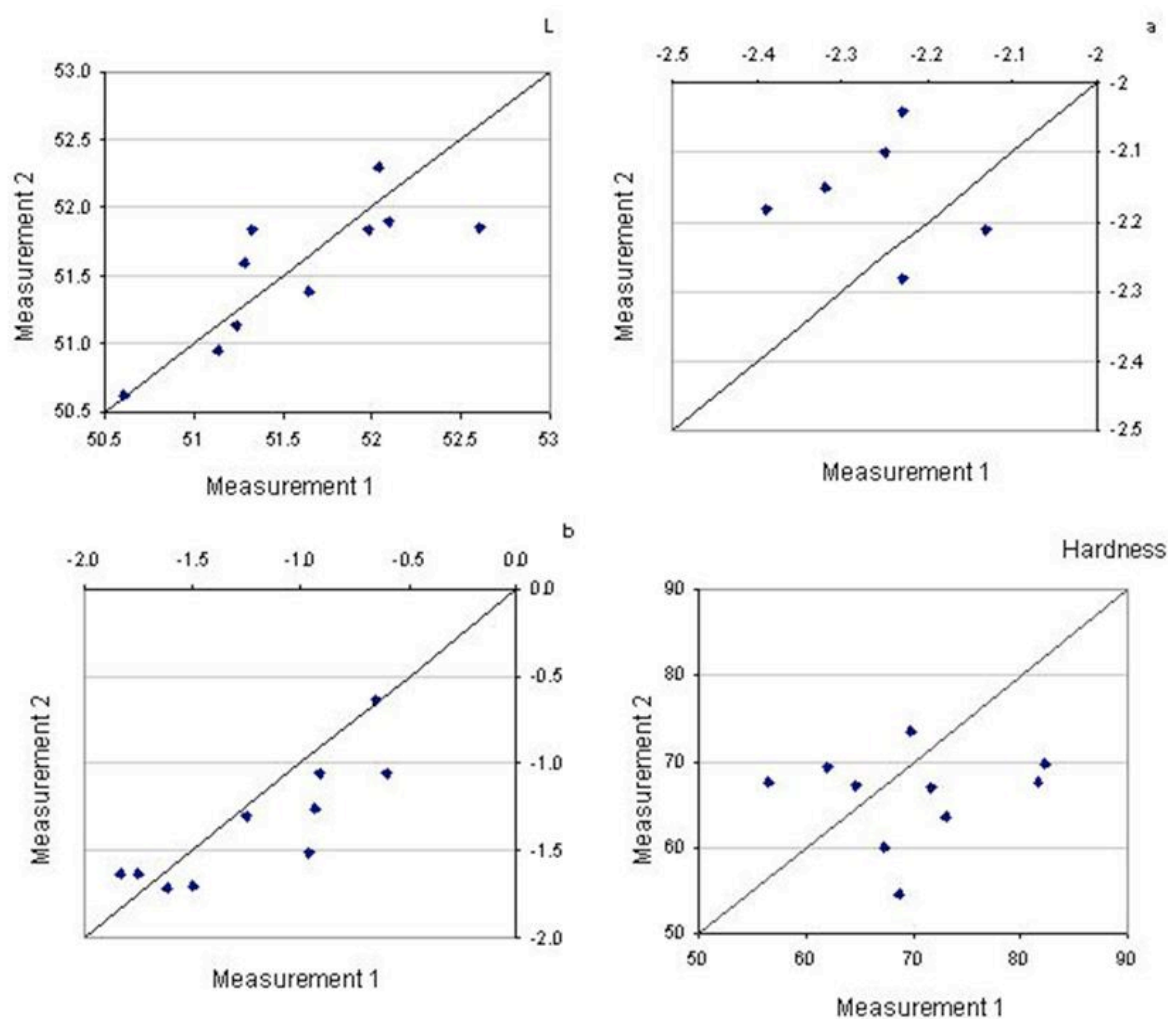

Figure 4 - Values obtained for color changing (coordinates L*, a*, b*) and hardness by examiner 2.

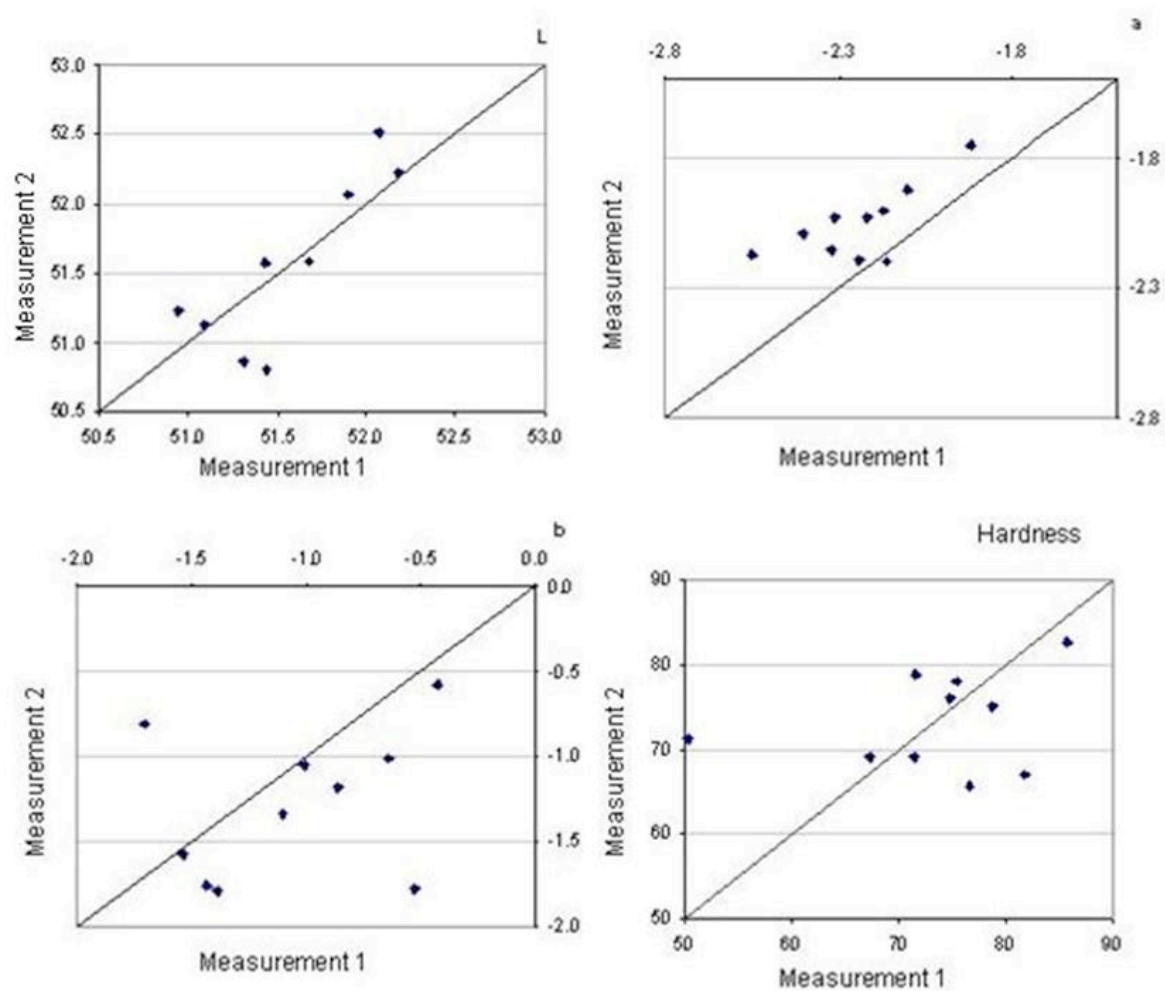

Figure 5 - Device used to standardize the specimen's position and decrease the influence from environment on color analysis with spectrophotometer.

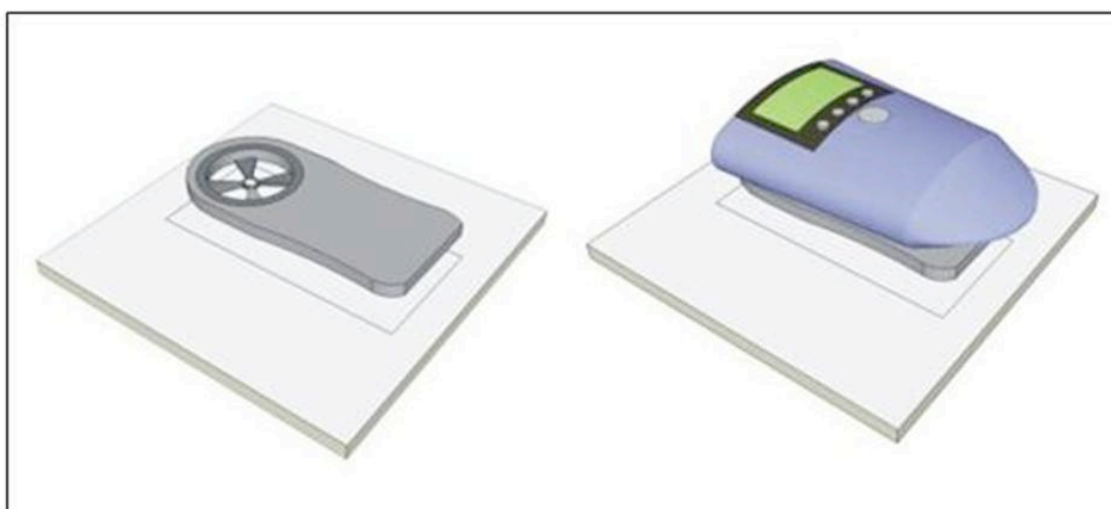

Figure 6 - Device positioned in the hardness tester for the measurements in three different areas (a, b and c).

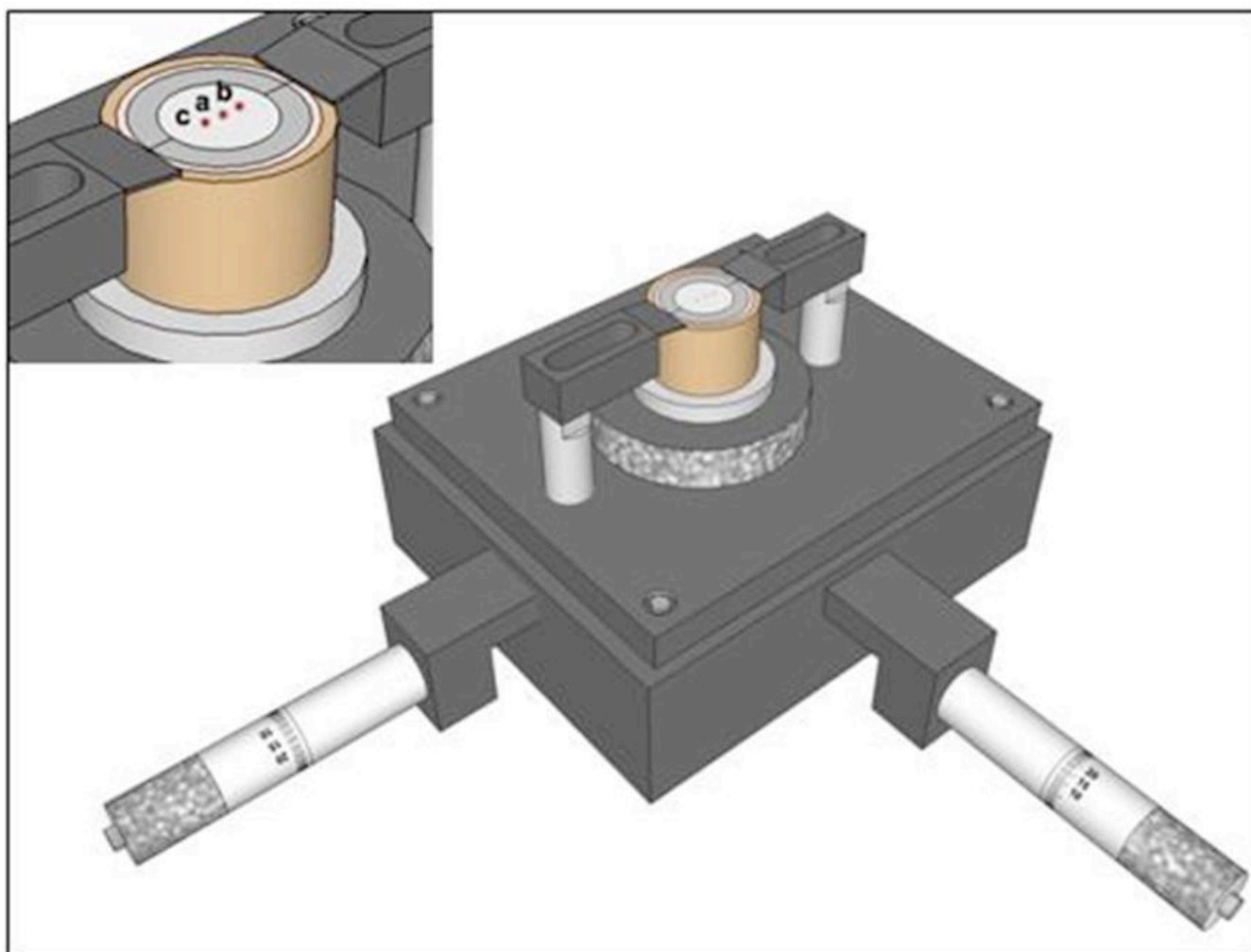

Table 3 - Intra and inter-examiner reproducibility on color changing (coordinates: L* - luminosity, a* - chromaticity red-green axis, b* - chromaticity yellow-blue axis) and hardness after adaptation of the methodology.

	Examiner 1	(classification) Examiner 2	Examiner 1 x 2
L*	0.8995 (Good)	0.9019 (Good)	0.8572 (Good)
a*	0.5880 (Moderate)	0.7553 (Good)	0.8729 (Good)
b*	0.7901 (Good)	0.9469 (Very good)	0.9115 (Very good)
Hardness	0.7504 (Good)	0.7142 (Good)	0.7887 (Good)

The data obtained by examiners 1 and 2 for the coordinates L *, a *, b * and hardness after adaptation of the methodology are shown in Figures 7 and 8, respectively.

Thus, it can be proven that the standardization, the training techniques of measurement and the quality control in data collection are important prerequisites for obtaining reliable information.^{4,11,12} Just following the

manufacturer's instructions do not guarantee a reliable study.

It should be clarified that the calibration of the examiners must be performed before the test, as fundamental and indispensable condition for

collecting reliable data. Furthermore, the ICC is a statistical technique recommended and easy to apply.

Figure 7 - Values obtained for color changing (coordinates L^* , a^* , b^*) and hardness by examiner 1 after adaptation of the methodology.

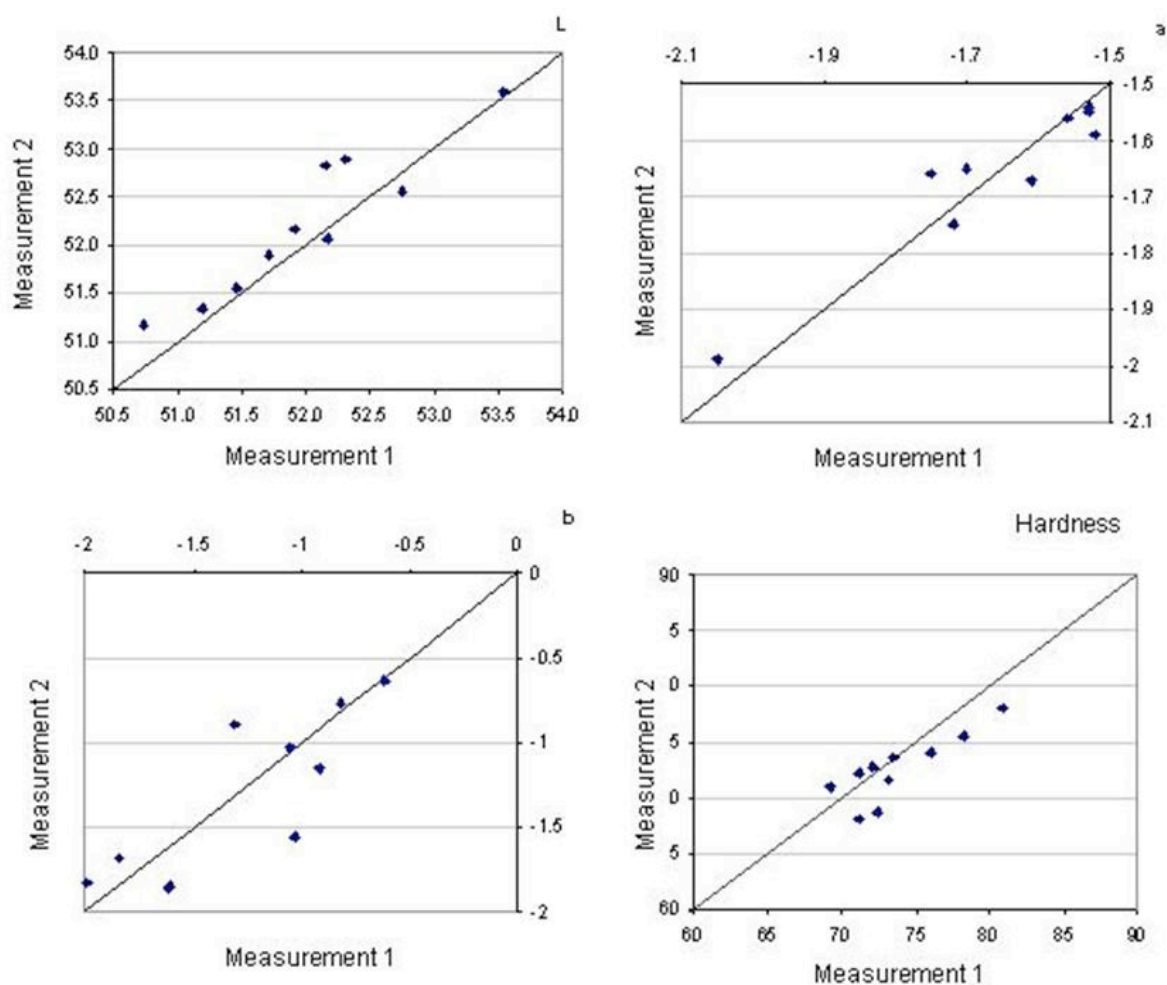
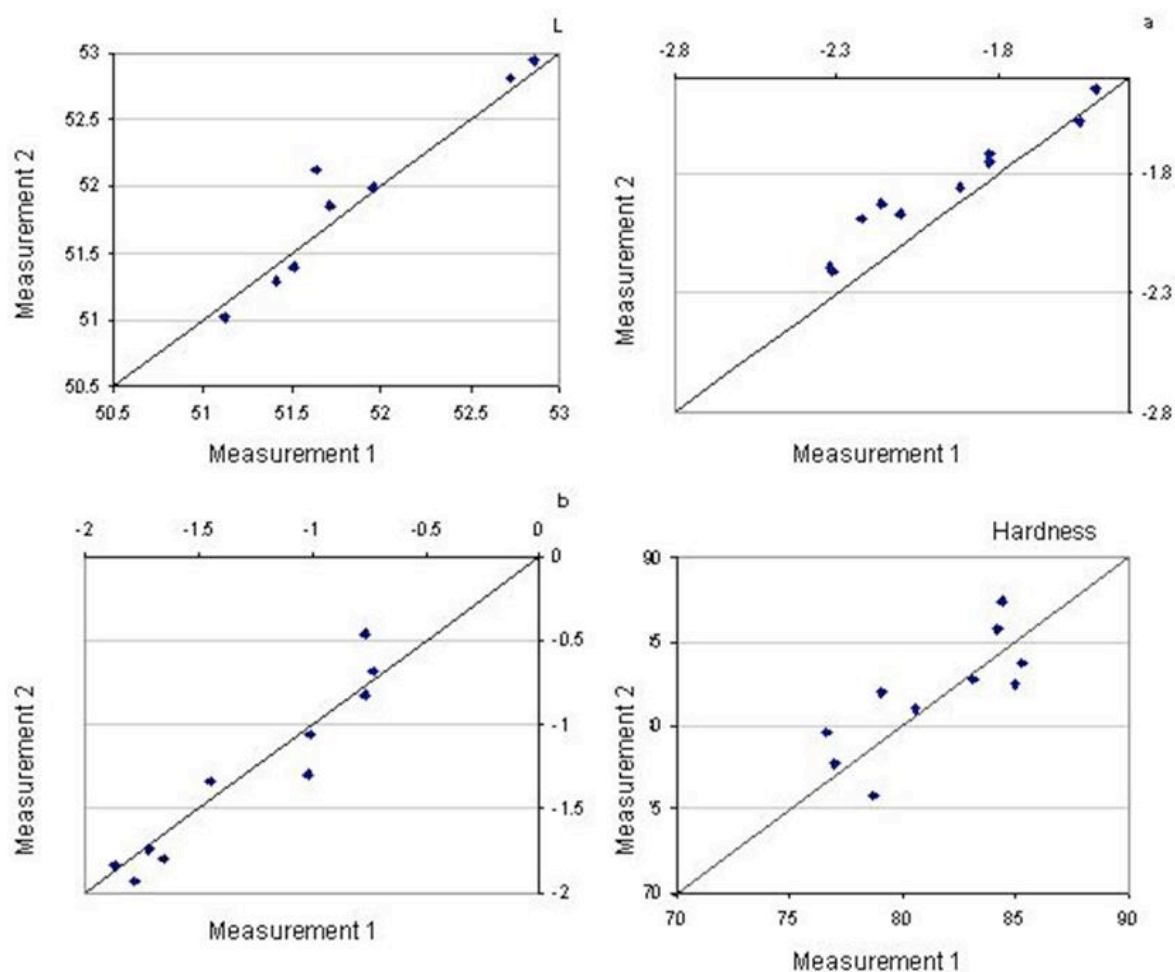

Figure 8 - Values obtained for color changing (coordinates L*, a*, b*) and hardness by examiner 1 after adaptation of the methodology.



CONCLUSION

Intra and inter-examiner calibration is essential for obtaining quality measurements in laboratory tests.

REFERENCES

1. Dunn G. Design and analysis of reliability studies. *Stat Methods Med Res.* 1992;1: 123-57.
2. Fermanian J. Measure de l'accord entre deux juges: cas quantitatif. *Rev Epidemiol Sante Publique.* 1984; 32: 408-13.
3. Fisher RA. Intraclass correlations and the analysis of variance. In: *Statistical methods for research workers.*

Edinburg: Oliver and Boyd; 1970. p. 213-249.

4. Loffredo LCM. Qualidade da informação em um trabalho científico. In: Grigolli AAG. *Metodologia do trabalho científico e recursos informacionais na área de saúde.* São Paulo: Editora Santos; 2008. p.155-66.
5. Snedecor GW, Cochran WC. One way classification. *Analysis of variance.* In: Snedecor GW. *Statistical methods.* Iowa : The Iowa State College Press; 1967. p. 258-96.
6. Santos PA, Garcia PPNS, Oliveira ALBM, Palma-Dibb RG. Chemical and morphological features of dental

composite resin: influence of light curing units and immersion media. *Microsc Res Tech.* 2010; 73: 176-81.

7. Oliveira AL, Domingos PA, Palma-Dibb RG, Garcia PP. Chemical and morphological features of nanofilled composite resin: influence of finishing and polishing procedures and fluoride solutions. *Microsc Res Tech.* 2012;75: 212-9.

8. Oliveira ALBM, Garcia PPNS, Santos PA, Campos JADB. Surface Roughness and Hardness of a Composite Resin: Influence of Finishing and Polishing and Immersion Methods. *Mat Res.* 2010; 13: 409-15.

9. Domingos PAS, Garcia PPNS, Oliveira ALBM, Palma-Dibb RG. Composite resin color stability: influence of light sources and immersion media. *J. Appl. Oral Sci.* 2011; 19: 204-11.

10. Bulman JS, Osborn JF. Measuring diagnostic consistency. *Br Dent J.* 1989; 166: 377-81.

11. Klipstein-Grobusch K, Georg T, Boeing H. Interviewer variability in anthropometric measurements and estimates of body composition. *Int J Epidemiol.* 1997; 26: 174-80.

12. Ruiz RE, Morales SVMM, Tomas SI, Gonzales ST, Peris VMT, Domingo CME. A reliability study of pediatric somatometric determinations and the level of agreement between 4 observers. *Aten Primaria.* 1999; 24: 255-8.