

## THE REEB GRAPH OF A MAP GERM FROM $\mathbb{R}^3$ TO $\mathbb{R}^2$ WITH ISOLATED ZEROS

ERICA BOIZAN BATISTA<sup>1</sup>, JOÃO CARLOS FERREIRA COSTA<sup>2</sup> AND  
JUAN J. NUÑO-BALLESTEROS<sup>3</sup>

<sup>1</sup>*Departamento de Matemática, Universidade Federal de São Carlos, Caixa Postal 676, 13560-905, São Carlos-SP, Brazil (ericabbatista@gmail.com)*

<sup>2</sup>*Departamento de Matemática, IBILCE-UNESP, Campus de São José do Rio Preto-SP, Brazil (jcosta@ibilce.unesp.br)*

<sup>3</sup>*Departament de Geometria i Topologia, Universitat de València, Campus de Burjassot 46100, Spain (juan.nuno@uv.es)*

(Received 20 November 2013)

*Abstract* We consider finitely determined map germs  $f: (\mathbb{R}^3, 0) \rightarrow (\mathbb{R}^2, 0)$  with  $f^{-1}(0) = \{0\}$  and we look at the classification of this kind of germ with respect to topological equivalence. By Fukuda's cone structure theorem, the topological type of  $f$  can be determined by the topological type of its associated link, which is a stable map from  $S^2$  to  $S^1$ . We define a generalized version of the Reeb graph for stable maps  $\gamma: S^2 \rightarrow S^1$ , which turns out to be a complete topological invariant. If  $f$  has corank 1, then  $f$  can be seen as a stabilization of a function  $h_0: (\mathbb{R}^2, 0) \rightarrow (\mathbb{R}, 0)$ , and we show that the Reeb graph is the sum of the partial trees of the positive and negative stabilizations of  $h_0$ . Finally, we apply this to give a complete topological description of all map germs with Boardman symbol  $\Sigma^{2,1}$ .

*Keywords:* topological equivalence; classification; link; Reeb graph

2010 *Mathematics subject classification:* Primary 58K15; 58K40; 58K65

### 1. Introduction

The classification of singular points of  $C^\infty$  map germs is one of the most important problems in singularity theory. The classical classification is done via  $\mathcal{A}$ -equivalence, where we take  $C^\infty$ -diffeomorphism germs in the source and the target. However, this is a difficult problem that imposes a lot of rigidity. Given this, it seems natural to investigate the classification of map germs up to weaker equivalence relations. Here we consider topological equivalence or  $C^0$ - $\mathcal{A}$ -equivalence, where the changes of coordinates are homeomorphisms instead of  $C^\infty$ -diffeomorphisms. Even in this case, Nakai showed in [17] that there are moduli in the topological classification of polynomial map germs  $f: (\mathbb{R}^3, 0) \rightarrow (\mathbb{R}^2, 0)$ .

This paper is devoted to the topological classification of  $C^\infty$  map germs from  $\mathbb{R}^3$  to  $\mathbb{R}^2$  that are finitely determined. Finite determinacy is a key notion in singularity theory because if  $f: (\mathbb{R}^3, 0) \rightarrow (\mathbb{R}^2, 0)$  is finitely determined, then it may be assumed to be

polynomial. Restricted to the class of finitely determined map germs from  $\mathbb{R}^3$  to  $\mathbb{R}^2$  of a given degree, it follows from Thom or Nishimura's work (see [18, 23]) that the number of topological types is finite. In other words, this problem is tame in the sense that it does not have topological moduli.

The topological structure of a finitely determined map germ  $f: (\mathbb{R}^3, 0) \rightarrow (\mathbb{R}^2, 0)$  is determined by the so-called link of  $f$  (see [6]). The link of  $f$  is obtained by taking a small enough representative  $f: U \subset \mathbb{R}^3 \rightarrow \mathbb{R}^2$  and the intersection of its image with a small enough sphere  $S_\delta^1$  centred at the origin in  $\mathbb{R}^2$ . When  $f$  has isolated zeros (i.e.  $f^{-1}(0) = \{0\}$ ) the link is a stable map  $\gamma: S^2 \rightarrow S^1$  and  $f$  is topologically equivalent to the cone of  $\gamma$ . As a consequence, two finitely determined map germs  $f, g: (\mathbb{R}^3, 0) \rightarrow (\mathbb{R}^2, 0)$  are topologically equivalent if their associated links are topologically equivalent. Then some open problems arise in a natural way related to our classification problem.

- (1) Find a good combinatorial model to describe the topology of stable maps from  $S^2$  to  $S^1$ .
- (2) Show that if  $f, g$  are topologically equivalent, then their associated links are also topologically equivalent.
- (3) Find relations between the analytic invariants of  $f$  (for example, corank, Boardman symbol, etc.) and the topological invariants of the link.
- (4) Characterize all the stable maps that can be realized as the link of a finitely determined map germ  $f: (\mathbb{R}^3, 0) \rightarrow (\mathbb{R}^2, 0)$ .

Inspired by the work of Arnold, Prishlyak and Sharko (see [1, 19, 22]), we introduce in §3 an adapted version of the Reeb graph to answer problem (1). The classical Reeb graph is defined for a Morse function  $\gamma: M \rightarrow \mathbb{R}$ , but here we have to extend it to the case in which the map takes values on  $S^1$  instead of  $\mathbb{R}$ . Then our generalized version of the Reeb graph turns out to be a complete topological invariant for stable maps  $\gamma: S^2 \rightarrow S^1$  (see Corollary 3.11). Moreover, the Reeb graph is also the key tool that gives the answer to problem (2) (Corollary 3.14).

In §4 we direct special attention to the case in which  $f$  has corank 1. In this case,  $f$  can be written as  $f(x, y, z) = (x, h_x(y, z))$  and gives a stabilization of  $h_0: (\mathbb{R}^2, 0) \rightarrow (\mathbb{R}, 0)$ . The topology of  $f$  is now determined by the two stabilizations  $h_x^+$ , with  $x > 0$ , and  $h_x^-$ , with  $x < 0$ . We introduce the notion of partial trees associated with  $h_x^+$  and  $h_x^-$  and show that the sum of the partial trees is equivalent to the Reeb graph of the link of  $f$  (Theorem 4.10). In the last part we give a complete description of those map germs with Boardman symbol  $\Sigma^{2,1}$  and provide a complete topological classification of this type of map germ up to multiplicity 6 (Theorem 4.13). This partly answers problems (3) and (4).

The case in which  $f$  has non-isolated zeros (i.e.  $f^{-1}(0) \neq \{0\}$ ) is more complicated. In that case the link is a stable map  $\gamma: M \rightarrow S^1$ , where  $M$  is now a compact surface with boundary and genus zero. However, we need a generalized version of the cone to describe the topology of  $f$  (see [3]). The topological classification of map germs with non-isolated zeros will be considered in a forthcoming paper [2].

Some recent papers treat the topological classification of finitely determined map germs  $f: (\mathbb{R}^n, 0) \rightarrow (\mathbb{R}^p, 0)$  by looking at the topological type of the link (see, for instance, [3, 11, 14–16]). However, as far as we know, this is the first time that it is considered for the  $n > p$  case.

All map germs considered are  $C^\infty$  unless otherwise stated. We adopt the usual notation and basic definitions that are common in singularity theory (for example,  $\mathcal{A}$ -equivalence, finite determinacy, stability, bifurcation set, etc.) and that the reader can find in Wall’s survey paper [24].

## 2. Finite determinacy and the link of a map germ

Two  $C^\infty$  map germs  $f, g: (\mathbb{R}^3, 0) \rightarrow (\mathbb{R}^2, 0)$  are  $\mathcal{A}$ -equivalent if there exist  $C^\infty$ -diffeomorphism germs  $\psi: (\mathbb{R}^3, 0) \rightarrow (\mathbb{R}^3, 0)$  and  $\phi: (\mathbb{R}^2, 0) \rightarrow (\mathbb{R}^2, 0)$  such that  $f = \phi \circ g \circ \psi$ . If  $\phi, \psi$  are homeomorphisms instead of  $C^\infty$ -diffeomorphisms, then we say that  $f$  and  $g$  are *topologically equivalent* (or  $C^0$ - $\mathcal{A}$ -equivalent).

For simplicity, we write just diffeomorphism instead of  $C^\infty$ -diffeomorphism.

We say that  $f: (\mathbb{R}^3, 0) \rightarrow (\mathbb{R}^2, 0)$  is  $k$ -determined if for any map germ  $g$  with the same  $k$ -jet we have that  $g$  is  $\mathcal{A}$ -equivalent to  $f$ . We say that  $f$  is finitely determined if it is  $k$ -determined for some  $k$ .

Let  $f: U \rightarrow \mathbb{R}^2$  be a  $C^\infty$  map, where  $U \subset \mathbb{R}^3$  is an open subset. We denote by  $S(f) = \{p \in U \mid Jf(p) \text{ does not have rank } 2\}$  the *singular set* of  $f$ , where  $Jf(p)$  is the Jacobian matrix of  $f$ . We also denote the *discriminant set* of  $f$  by  $\Delta(f) = f(S(f))$ .

When we start a classification of generic singularities, the first step is to describe the stable singularities. The characterization of stable singularities of maps from  $\mathbb{R}^3$  to  $\mathbb{R}^2$  is well known (see [7]) and is given by the following proposition.

**Proposition 2.1.** *Let  $f: (\mathbb{R}^3, S) \rightarrow (\mathbb{R}^2, 0)$  be a  $C^\infty$  multigerms germ such that  $f$  is singular at each point of  $S$ . Then  $f$  is stable if only if  $|S| \leq 2$  and  $f$  is  $\mathcal{A}$ -equivalent to one of the following normal forms.*

(1) For  $|S| = 1$ :

- $(x, y^2 + z^2)$ , called a *definite fold point*  $D$ ;
- $(x, y^2 - z^2)$ , called an *indefinite fold point*  $I$ ;
- $(x, y^3 + xy + z^2)$ , called a *cuspidal point*.

(2) For  $|S| = 2$ :

- $(x_1, y_1^2 + z_1^2), (y_2^2 + z_2^2, x_2)$ , called a *nodefold*  $D\&D$ ;
- $(x_1, y_1^2 + z_1^2), (y_2^2 - z_2^2, x_2)$ , called a *nodefold*  $D\&I$ ;
- $(x_1, y_1^2 - z_1^2), (y_2^2 - z_2^2, x_2)$ , called a *nodefold*  $I\&I$ .

The classification of monogerms can be obtained easily by using Mather’s techniques of classification of local  $\mathbb{R}$ -algebras. For multigerms, we use the following fact: given

$S = \{x_1, \dots, x_r\} \subset \mathbb{R}^n$ , a multigerms  $f: (\mathbb{R}^n, S) \rightarrow (\mathbb{R}^p, 0)$  is stable if and only if each branch  $f_i: (\mathbb{R}^n, x_i) \rightarrow (\mathbb{R}^p, 0)$  is stable and the spaces

$$df_{x_1}(T_{x_1}A(f_1)), \dots, df_{x_r}(T_{x_r}A(f_r))$$

are in general position in  $\mathbb{R}^p$  (here  $A(f_i)$  denotes the analytic stratum of  $f_i$ , that is, the submanifold of points  $x$  in  $\mathbb{R}^n$  such that the germ of  $f_i$  at  $x$  is  $\mathcal{A}$ -equivalent to the germ  $f_i$  at  $x_i$ ). In our case,  $n = 3$  and  $p = 2$ , there are only three algebras whose contact class in the jet space has codimension less than or equal to 3, corresponding to the three monogermers in the list above. For multigerms, we have to combine the three types in such a way that they intersect transversely, obtaining only the three types of stable bigerms.

When  $f: (\mathbb{R}^n, 0) \rightarrow (\mathbb{R}^p, 0)$  is not stable but it is finitely determined, then roughly speaking  $f$  has an isolated instability at the origin. This is known as the Mather–Gaffney finite determinacy criterion [24]. In fact, the Mather–Gaffney criterion is valid for holomorphic map germs  $f: (\mathbb{C}^n, 0) \rightarrow (\mathbb{C}^p, 0)$ , but we can obtain some consequences of this criterion in the real case as follows.

**Theorem 2.2.** *A holomorphic map germ  $f: (\mathbb{C}^n, 0) \rightarrow (\mathbb{C}^p, 0)$  is finitely determined if and only if there is a representative  $f: U \subset \mathbb{C}^n \rightarrow \mathbb{C}^p$  such that*

(i)  $S(f) \cap f^{-1}(0) = \{0\}$ ,

(ii) *for every finite subset  $S \subset U - \{0\}$  the multigerms of  $f$  at  $S$  is stable.*

Since our case of interest is  $n = 3$  and  $p = 2$ , from condition (ii) the cusps and the nodefolds are isolated points in  $U - \{0\}$ . Then we can shrink the neighbourhood  $U$  if necessary in Theorem 2.2 to get a representative  $f: U \subset \mathbb{C}^3 \rightarrow \mathbb{C}^2$  such that the restriction  $f|_{U - \{0\}}$  has only simple fold singularities. The word simple here means that the folds are not double points.

Coming back to the real case, we now consider a finitely determined map germ  $f: (\mathbb{R}^3, 0) \rightarrow (\mathbb{R}^2, 0)$ . After coordinate changes in the source and the target, we can assume that  $f$  is polynomial. If  $f_{\mathbb{C}}: (\mathbb{C}^3, 0) \rightarrow (\mathbb{C}^2, 0)$  is the complexification of  $f$ , it follows from Wall’s survey paper [24] that  $f_{\mathbb{C}}$  is also finitely determined. Then we have as a consequence of Theorem 2.2 the following real criterion.

**Corollary 2.3.** *Let  $f: (\mathbb{R}^3, 0) \rightarrow (\mathbb{R}^2, 0)$  be a finitely determined map germ. Then there exists a representative  $f: U \subset \mathbb{R}^3 \rightarrow \mathbb{R}^2$  such that*

(i)  $S(f) \cap f^{-1}(0) = \{0\}$ ,

(ii) *the restriction  $f|_{U - \{0\}}$  has only definite and indefinite simple fold singularities.*

If  $f$  is finitely determined, then its discriminant  $\Delta(f)$  is a plane curve with an isolated singularity at the origin. The number of half-branches of  $\Delta(f)$  will play a crucial role in the analysis of the Reeb graph associated with a link of  $f$  and, consequently, in the topological classification of  $f$ .

Denote by  $J^r(n, p)$  the  $r$ -jet space from  $(\mathbb{R}^n, 0)$  to  $(\mathbb{R}^p, 0)$ . For positive integers  $r$  and  $s$  with  $s \geq r$ , let  $\pi_r^s: J^s(n, p) \rightarrow J^r(n, p)$  be the canonical projection defined by  $\pi_r^s(j^s f(0)) = j^r f(0)$ . For a positive number  $\varepsilon > 0$  we set

$$D_\varepsilon^n = \{x \in \mathbb{R}^n \mid \|x\|^2 \leq \varepsilon\},$$

$$B_\varepsilon^n = \{x \in \mathbb{R}^n \mid \|x\|^2 < \varepsilon\}$$

and

$$S_\varepsilon^{n-1} = \{x \in \mathbb{R}^n \mid \|x\|^2 = \varepsilon\}.$$

We denote by  $D^n$ ,  $B^n$  and  $S^{n-1}$  the standard disc, the ball and the sphere of radius 1, respectively.

Fukuda proved the following cone structure theorem in [5, 6].

**Theorem 2.4.** *For any semi-algebraic subset  $W$  of  $J^r(n, p)$  there exists an integer  $s$  ( $s \geq r$ ) depending only on  $n, p$  and  $r$ , and there exists a closed semi-algebraic subset  $\Sigma_W$  of  $(\pi_r^s)^{-1}(W)$  having codimension greater than or equal to 1 such that for any  $C^\infty$  map  $f: \mathbb{R}^n \rightarrow \mathbb{R}^p$  with  $j^s f(0)$  belonging to  $(\pi_r^s)^{-1}(W) \setminus \Sigma_W$  we have the following properties.*

**Case A ( $f^{-1}(0) = \{0\}$ ).** *There is an  $\varepsilon_0 > 0$  such that for any number  $\varepsilon$  with  $0 < \varepsilon \leq \varepsilon_0$  we have:*

- (i) *the set  $\tilde{S}_\varepsilon^{n-1} = f^{-1}(S_\varepsilon^{p-1})$  is a  $C^\infty$  submanifold without boundary that is diffeomorphic to the standard unit sphere  $S^{n-1}$ ;*
- (ii) *the restricted map  $f|_{\tilde{S}_\varepsilon^{n-1}}: \tilde{S}_\varepsilon^{n-1} \rightarrow S_\varepsilon^{p-1}$  is topologically stable ( $C^\infty$  stable if  $(n, p)$  is a nice pair in Mather's sense);*
- (iii) *if  $\tilde{D}_\varepsilon^{n-1} = f^{-1}(D_\varepsilon^{p-1})$ , then the restricted map  $f|_{\tilde{D}_\varepsilon^{n-1}}: \tilde{D}_\varepsilon^{n-1} \rightarrow D_\varepsilon^p$  is topologically equivalent to the cone of  $f|_{\tilde{S}_\varepsilon^{n-1}}$ .*

**Case B ( $f^{-1}(0) \neq \{0\}$ ).** *There exist a positive number  $\varepsilon_0$  and a strictly increasing  $C^\infty$  function  $\delta: [0, \varepsilon_0] \rightarrow [0, \infty)$  with  $\delta(0) = 0$  such that for every  $\varepsilon$  and  $\delta$  with  $0 < \varepsilon \leq \varepsilon_0$  and  $0 < \delta \leq \delta(\varepsilon)$  we have:*

- (i)  *$f^{-1}(0) \cap S_\varepsilon^{n-1}$  is an  $(n - p - 1)$ -dimensional manifold and it is diffeomorphic to  $f^{-1}(0) \cap S_{\varepsilon_0}^{n-1}$ ;*
- (ii)  *$D_\varepsilon^n \cap f^{-1}(S_\delta^{p-1})$  is a  $C^\infty$  manifold, generally with boundary, and it is diffeomorphic to  $D_{\varepsilon_0}^n \cap f^{-1}(S_{\delta(\varepsilon_0)}^{p-1})$ ;*
- (iii) *the restriction  $f|_{D_\varepsilon^n \cap f^{-1}(S_\delta^{p-1})}: D_\varepsilon^n \cap f^{-1}(S_\delta^{p-1}) \rightarrow S_\delta^{p-1}$  is a topologically stable map ( $C^\infty$  stable if  $(n, p)$  is a nice pair in Mather's sense) and its topological class is independent of  $\varepsilon$  and  $\delta$ .*

**Remark 2.5.** In the original version of Fukuda's theorem [5], Case A (i) has the restriction  $n \neq 4, 5$ . The reason is that the proof uses the generalized Poincaré conjecture, but at that time the conjecture was known to be true only in dimensions not equal to 3, 4.

Assuming that  $f$  is  $r$ -determined for some  $r$  and taking  $W = \{j^r f(0)\}$ , we can apply Theorem 2.4 to obtain a representative of  $f$  satisfying Case A or Case B, depending on if  $f^{-1}(0) = \{0\}$  or  $f^{-1}(0) \neq \{0\}$ . Note that when  $n \leq p$  we always have  $f^{-1}(0) = \{0\}$  but when  $n > p$  we may have either of the two possibilities.

**Definition 2.6.** Let  $f: (\mathbb{R}^3, 0) \rightarrow (\mathbb{R}^2, 0)$  be a finitely determined map germ such that  $f^{-1}(0) = \{0\}$ . We say that the stable map  $f|_{\tilde{S}_\varepsilon^2}: \tilde{S}_\varepsilon^2 \rightarrow S_\varepsilon^1$  is the *link* of  $f$ , where  $f$  is a representative that satisfies the Fukuda conditions of Case A of Theorem 2.4 adapted for the case in which  $n = 3$  and  $p = 2$ .

It follows from the definition that the link of  $f$  is a stable map  $\gamma: S^2 \rightarrow S^1$ , that is,  $\gamma$  has only Morse singularities with distinct critical values. Moreover, the link is well defined up to  $\mathcal{A}$ -equivalence and  $f$  is topologically equivalent to the cone of  $\gamma$ . Hence, we have the following immediate consequence.

**Corollary 2.7.** *Two finitely determined map germs  $f, g: (\mathbb{R}^3, 0) \rightarrow (\mathbb{R}^2, 0)$  with  $f^{-1}(0) = \{0\} = g^{-1}(0)$  are topologically equivalent if their associated links are topologically equivalent.*

**Remark 2.8.** When  $f^{-1}(0) \neq \{0\}$ , it is also common to call the link of  $f$  to the stable map  $f|_{D_\varepsilon^3 \cap f^{-1}(S_\delta^1)}: D_\varepsilon^3 \cap f^{-1}(S_\delta^1) \rightarrow S_\delta^1$ , where  $f$  is a representative that satisfies the Fukuda conditions of Case B of Theorem 2.4 adapted for case in which  $n = 3$  and  $p = 2$ . However, in this case,  $f$  is not topologically equivalent to the cone of the link in the classical sense. Instead of this, we have to consider a generalized version of the cone that turns out to be topologically equivalent to  $f$  (see [3] for details). The topological classification of this class of map germs will be considered in a forthcoming paper [2].

### 3. The generalized Reeb graph

The Reeb graph was introduced by Reeb in [20] and it is well known that it is a complete topological invariant for Morse functions from  $S^2$  to  $\mathbb{R}$  (see [1, 22]). In this section we extend the concept of a Reeb graph to stable maps from  $S^2$  to  $S^1$ .

**Proposition 3.1.** *Let  $\gamma: S^2 \rightarrow S^1$  be a stable map. Then  $\gamma$  is not a regular map.*

**Proof.** Suppose that  $\gamma$  is a regular map; then  $\gamma(S^2) \subset S^1$  would be an open set. Since  $\gamma(S^2)$  is also closed, we get  $\gamma(S^2) = S^1$ , and hence  $\gamma$  is surjective. By Ehresmann's fibration theorem [4],  $f$  is a locally trivial fibration. In particular, if  $F$  is a fibre we have that

$$2 = \chi(S^2) = \chi(S^1)\chi(F) = 0,$$

which is absurd. □

Given a continuous map  $f: X \rightarrow Y$  between topological spaces, we consider the following equivalence relation on  $X$ :  $x \sim y \iff f(x) = f(y)$  and  $x$  and  $y$  are in the same connected component of  $f^{-1}(f(x))$ .

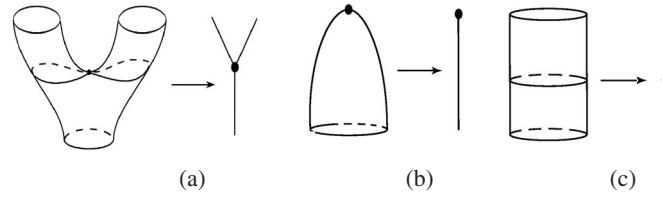

Figure 1. Vertices of Reeb graphs.

**Proposition 3.2.** *Let  $\gamma: S^2 \rightarrow S^1$  be a stable map. Then the quotient space  $S^2/\sim$  admits the structure of a connected graph in the following way:*

- (1) *the vertices are the connected components of level curves  $\gamma^{-1}(v)$ , where  $v \in S^1$  is a critical value;*
- (2) *each edge is formed by points that correspond to connected components of level curves  $\gamma^{-1}(v)$ , where  $v \in S^1$  is a regular value.*

**Proof.** Since  $\gamma$  is stable, we have a finite number of critical values  $v_1, \dots, v_r$  and for each  $i = 1, \dots, r$ ,  $\gamma^{-1}(v_i)$  has a finite number of connected components. Then

$$\gamma|_{S^2 - \gamma^{-1}(\{v_1, \dots, v_r\})}: S^2 - \gamma^{-1}(\{v_1, \dots, v_r\}) \rightarrow S^1 - \{v_1, \dots, v_r\}$$

is regular and the induced map

$$\tilde{\gamma}: (S^2 - \gamma^{-1}(\{v_1, \dots, v_r\}))/\sim \rightarrow S^1 - \{v_1, \dots, v_r\}$$

is a local homeomorphism. Each connected component of  $S^1 - \{v_1, \dots, v_r\}$  is homeomorphic to an open interval, so each connected component of  $(S^2 - \gamma^{-1}(\{v_1, \dots, v_r\}))/\sim$  is also homeomorphic to an open interval.  $\square$

Each vertex of the graph can be of three types, depending on if the connected component has a maximum/minimum critical point, a saddle point or just regular points. Then the possible incidence rules of edges and vertices are given in Figure 1.

Let  $v_1, \dots, v_r \in S^1$  be the critical values of  $\gamma$ . We choose a base point  $v_0 \in S^1$  and an orientation. We can reorder the critical values such that  $v_0 \leq v_1 < \dots < v_r$  and we label each vertex with the index  $i \in \{1, \dots, r\}$  if it corresponds to the critical value  $v_i$ .

**Definition 3.3.** The graph given by  $S^2/\sim$ , together with the labels of the vertices as previously defined, is said to be the *generalized Reeb graph* associated with  $\gamma: S^2 \rightarrow S^1$ .

For simplicity, from now on we will just say Reeb graph as opposed to generalized Reeb graph unless otherwise specified.

**Proposition 3.4.** *Let  $\gamma: S^2 \rightarrow S^1$  be a stable map. Then the Reeb graph of  $\gamma$  is a tree.*

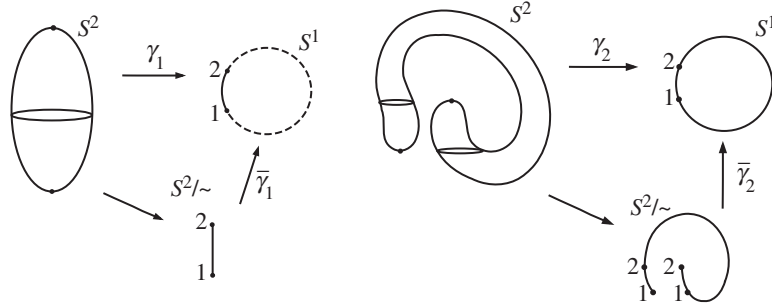

Figure 2. Two non-equivalent stable maps with the same Reeb graph.

**Proof.** Let  $\Gamma$  be the Reeb graph of  $\gamma$ . Since  $\Gamma$  is connected, in order to show that  $\Gamma$  is a tree we only need to prove that its Euler characteristic is  $\chi(\Gamma) = 1$ . We have that  $\chi(\Gamma) = V - E$ , where  $V$  and  $E$  denote the number of vertices and edges of  $\Gamma$ , respectively.

On one hand,  $V = M + S + I$ , where  $M, S, I$  denote the numbers of vertices of each type, maximum/minimum, saddle or regular, respectively. Note that  $V \neq 0$  by Proposition 3.1.

On the other hand, by Euler’s formula,  $E = \frac{1}{2} \sum \deg(v_i)$ , where  $v_i$  are the vertices of  $\Gamma$  and  $\deg(v_i)$  is the degree of  $v_i$ , that is, the number of edges adjacent to  $v_i$ . Since  $\gamma$  is stable, the degree of each vertex of maximum/minimum type is 1, while that of regular type is 2 and that of saddle type is 3 (see Figure 1). Hence,

$$\chi(\Gamma) = V - E = M + S + I - \frac{1}{2}(M + 2I + 3S) = \frac{M - S}{2} = 1,$$

where the last equality follows from the Morse formula  $M - S = \chi(S^2) = 2$ . □

**Remark 3.5.** The classical Reeb graph is defined in the same way, but the vertices are just the connected components of the level curves  $\gamma^{-1}(v)$  that contain a critical point. Hence, our generalized Reeb graph contains some extra vertices corresponding to the regular connected components of  $\gamma^{-1}(v)$ , where  $v$  is a critical value. Of course the classical Reeb graph can be obtained from the generalized one just by eliminating the extra vertices and joining the two adjacent edges. But in general, the generalized Reeb graph provides more information.

We present in Figure 2 two examples of stable maps  $\gamma_1, \gamma_2: S^2 \rightarrow S^1$  with their respective generalized Reeb graphs. Both examples share the same classical Reeb graph, but the generalized Reeb graphs are different. The example on the left-hand side is a non-surjective map, while the map on the right-hand side is surjective, therefore the maps are not topologically equivalent. This shows that the classical Reeb graph is not sufficient to distinguish between these two examples.

Notice that if  $\gamma: S^2 \rightarrow S^1$  is not surjective, then  $\gamma$  may be regarded as a Morse function from  $S^2$  to  $\mathbb{R}$  (via stereographic projection). In this case, the generalized Reeb graph can be deduced from the classical one just by adding the extra vertices each time that one passes through a critical value.



It is obvious that the labelling of vertices of the Reeb graph is not uniquely determined, since it depends on the chosen orientations and the base points on each  $S^1$ . Different choices will produce either a cyclic permutation or a reversal of the labelling in the Reeb graph. This leads us to the following definition of equivalent Reeb graphs.

Let  $\gamma, \delta: S^2 \rightarrow S^1$  be two stable maps. Let  $\Gamma_\gamma$  and  $\Gamma_\delta$  be their respective Reeb graphs. Consider the induced quotient maps  $\bar{\gamma}: \Gamma_\gamma \rightarrow S^1_\gamma$  and  $\bar{\delta}: \Gamma_\delta \rightarrow S^1_\delta$ , where  $S^1_\gamma, S^1_\delta$  denote  $S^1$  with the graph structure whose vertices are the critical values of  $\gamma, \delta$ , respectively, as illustrated in Figure 2.

**Definition 3.6.** An *isomorphism* between two graphs  $\Gamma_1$  and  $\Gamma_2$  is a bijection  $f$  from  $V(\Gamma_1)$  to  $V(\Gamma_2)$  such that two vertices  $v$  and  $w$  are adjacent in  $\Gamma_1$  if and only if  $f(v)$  and  $f(w)$  are adjacent in  $\Gamma_2$ , where  $V(\Gamma_i) = \{\text{vertices of } \Gamma_i\}$ .

**Definition 3.7.** We say that  $\Gamma_\gamma$  is *equivalent* to  $\Gamma_\delta$ , and we denote this equivalence by  $\Gamma_\gamma \sim \Gamma_\delta$ , if there exist graph isomorphisms  $j: \Gamma_\gamma \rightarrow \Gamma_\delta$  and  $l: S^1_\gamma \rightarrow S^1_\delta$  such that the following diagram is commutative:

$$\begin{array}{ccc}
 V_\gamma & \xrightarrow{\bar{\gamma}|_{V_\gamma}} & \Delta_\gamma \\
 j|_{V_\gamma} \downarrow & & \downarrow l|_{\Delta_\gamma} \\
 V_\delta & \xrightarrow{\bar{\delta}|_{V_\delta}} & \Delta_\delta
 \end{array}$$

where  $V_\gamma = \{\text{vertices of } \Gamma_\gamma\}$ ,  $V_\delta = \{\text{vertices of } \Gamma_\delta\}$  and  $\Delta_\gamma$  and  $\Delta_\delta$  are their respective discriminant sets.

**Theorem 3.8.** Let  $\gamma, \delta: S^2 \rightarrow S^1$  be two stable maps. If  $\gamma$  and  $\delta$  are topologically equivalent, then their respective Reeb graphs are equivalent.

**Proof.** Since  $\gamma$  and  $\delta$  are topologically equivalent, there exist homeomorphisms  $h: S^2 \rightarrow S^2$  and  $k: S^1 \rightarrow S^1$  such that  $k \circ \gamma \circ h = \delta$ . Then  $h$  maps critical points into critical points and  $k$  maps critical values into critical values. Hence,  $h$  induces a graph isomorphism from  $\Gamma_\gamma$  to  $\Gamma_\delta$  and  $k$  induces a graph isomorphism from  $S^1_\gamma$  to  $S^1_\delta$ , which gives the equivalence between the Reeb graphs. □

Theorem 3.8 allows us to extend the definition of a Reeb graph to  $C^0$ -stable maps between topological spheres.

**Definition 3.9.** Let  $\gamma: M \rightarrow P$  be a continuous map, where  $M$  is homeomorphic to  $S^2$  and  $P$  is homeomorphic to  $S^1$ . We say that  $\gamma$  is  *$C^0$ -stable* if there exist a stable  $C^\infty$  map  $\delta: S^2 \rightarrow S^1$  and homeomorphisms  $k: M \rightarrow S^2, h: P \rightarrow S^1$  such that the following diagram is commutative:

$$\begin{array}{ccc}
 M & \xrightarrow{\gamma} & P \\
 k \downarrow & & \downarrow h \\
 S^2 & \xrightarrow{\delta} & S^1
 \end{array}$$

We say that  $y \in P$  is a *critical value* of  $\gamma$  if  $h(y)$  is a critical value of  $\delta$ . Moreover,  $M/\sim$  has a graph structure induced by the Reeb graph of  $\delta$ . We call this graph the *Reeb graph* of  $\gamma$  and denote it by  $\Gamma_\gamma$ . The notion of equivalence of graphs given in Definition 3.7 can also be extended for  $C^0$ -stable maps in the obvious way. By Theorem 3.8, the Reeb graph  $\Gamma_\gamma$  is well defined up to equivalence of graphs.

**Theorem 3.10.** *Let  $\gamma, \delta: S^2 \rightarrow S^1$  be two stable maps such that  $\Gamma_\gamma \sim \Gamma_\delta$ . Then  $\gamma$  is  $\mathcal{A}$ -equivalent to  $\delta$ .*

**Proof.** This is an adaptation of the proof of [9, Theorem 4.1]. Since  $\Gamma_\gamma \sim \Gamma_\delta$ , there exist graph isomorphisms  $j: \Gamma_\gamma \rightarrow \Gamma_\delta$  and  $l: S_\gamma^1 \rightarrow S_\delta^1$  as in Definition 3.7. We choose a homeomorphism  $h: \Gamma_\gamma \rightarrow \Gamma_\delta$  and a diffeomorphism  $k: S_\gamma^1 \rightarrow S_\delta^1$  that realize the graph isomorphisms  $j, l$ , respectively, and such that  $\bar{\delta} \circ h = k \circ \bar{\gamma}$ .

Since  $k \circ \gamma$  is  $\mathcal{A}$ -equivalent to  $\gamma$ , by Theorem 3.8 we have  $\Gamma_{k \circ \gamma} \sim \Gamma_\gamma$ . Moreover, these graphs are the same because  $k \circ \bar{\gamma} = \overline{k \circ \gamma}$ . In other words, the following diagram is commutative:

$$\begin{array}{ccc} \Gamma_\delta & \xrightarrow{\bar{\delta}} & S^1 \\ \uparrow h & \nearrow \overline{k \circ \gamma} & \\ \Gamma_\gamma & & \end{array}$$

For simplicity, we write simply  $\gamma$  instead of  $k \circ \gamma$ . By construction,  $h(V_\gamma) = V_\delta$ , but now  $\gamma$  and  $\delta$  have the same critical values  $v_1, \dots, v_n \in S^1$ . We choose a base point and an orientation in  $S^1$  and assume that

$$v_1 < v_2 < \dots < v_n.$$

Denote by  $\text{arc}(a, b)$  the oriented arc from  $a$  to  $b$  in  $S^1$ , and by  $\overline{\text{arc}(a, b)}$  its closure. Let  $w_i$  be the middle point of  $\text{arc}(v_i, v_{i+1})$  for  $i = 1, \dots, n$  with  $v_{n+1} = v_1$ , and let  $\xi: S^1 \setminus \{w_n\} \rightarrow \mathbb{R}$  be an orientation-preserving diffeomorphism.

For each critical value  $v_i$  with  $i = 1, \dots, n$  we can choose  $\varepsilon_i > 0$  as in Definition A 6, and by Theorem A 14 there exists a diffeomorphism

$$h_i: (\xi \circ \gamma)^{-1}[\xi(v_i) - 2\varepsilon_i^2, \xi(v_i) + 2\varepsilon_i^2] \rightarrow (\xi \circ \delta)^{-1}[\xi(v_i) - 2\varepsilon_i^2, \xi(v_i) + 2\varepsilon_i^2]$$

such that  $\xi \circ \gamma = \xi \circ \delta \circ h_i$ . Since  $\xi$  is a diffeomorphism, it follows that  $\gamma = \delta \circ h_i$  when restricted to

$$\gamma^{-1}(\text{arc}(\xi^{-1}(\xi(v_i) - 2\varepsilon_i^2), \xi^{-1}(\xi(v_i) + 2\varepsilon_i^2))).$$

Let  $a_i, a_i^-, b_i, b_i^- \in S^1$  be given by

$$\begin{aligned} a_i &= \xi^{-1}(\xi(v_i) + 2\varepsilon_i^2), & a_i^- &= \xi^{-1}(\xi(v_i) - 2\varepsilon_i^2), \\ b_i &= \xi^{-1}(\xi(v_i) + \varepsilon_i^2), & b_i^- &= \xi^{-1}(\xi(v_i) - \varepsilon_i^2). \end{aligned}$$

Since  $\xi$  is orientation preserving,

$$w_i < a_i^- < b_i^- < v_i < b_i < a_i < w_{i+1}.$$

Define

$$\begin{aligned} A_i &= \gamma^{-1}(\overline{\text{arc}(a_i^-, a_i)}), & A'_i &= \delta^{-1}(\overline{\text{arc}(a_i^-, a_i)}), \\ B_i &= \gamma^{-1}(\overline{\text{arc}(b_i, b_{i+1}^-)}), & B'_i &= \delta^{-1}(\overline{\text{arc}(b_i, b_{i+1}^-)}) \end{aligned}$$

for  $i = 1, \dots, n$  with  $b_{n+1} = b_1$ . With this notation,  $h_i: \text{Int}(A_i) \rightarrow \text{Int}(A'_i)$  is a diffeomorphism such that  $\gamma = \delta \circ h_i$  on  $\text{Int}(A_i)$  for all  $i = 1, \dots, n$ .

Notice that  $\gamma|_{B_i}$  and  $\delta|_{B'_i}$  are regular maps for all  $i = 1, \dots, n$ . Then by Theorem A 4 there exist diffeomorphisms  $\phi_i$  and  $\psi_i$  such that the following diagrams are commutative:

$$\begin{array}{ccc} \gamma^{-1}(b_i) \times \text{arc}(b_i, b_{i+1}^-) & \xrightarrow{p} & \text{arc}(b_i, b_{i+1}^-) \\ \uparrow \phi_i & \nearrow \gamma|_{B_i} & \\ B_i & & \end{array} \quad \begin{array}{ccc} \delta^{-1}(b_i) \times \text{arc}(b_i, b_{i+1}^-) & \xrightarrow{\tilde{p}} & \text{arc}(b_i, b_{i+1}^-) \\ \uparrow \psi_i & \nearrow \delta|_{B'_i} & \\ B'_i & & \end{array}$$

where  $p$  and  $\tilde{p}$  are the projections to the second component.

Since the Reeb graphs of  $\gamma$  and  $\delta$  are equivalent, it follows that  $\gamma^{-1}(b_i)$  is diffeomorphic to  $\delta^{-1}(b_i)$ . Consequently,  $B_i$  is diffeomorphic to  $B'_i$  via a diffeomorphism that gives the  $\mathcal{A}$ -equivalence between  $\gamma|_{B_i}$  and  $\delta|_{B'_i}$ .

Notice that the boundary of  $A_i$  is diffeomorphic to a finite union of circles  $S^1$ . Then the diffeomorphisms  $h_i$  when restricted to the boundary of  $A_i$  may be assumed to be orientation preserving. Hence,  $h_i|_{\gamma^{-1}(b_i)}$  and  $h_{i+1}|_{\gamma^{-1}(b_{i+1}^-)}$  are isotopic because both are isotopic to the identity. Let

$$F_i: \gamma^{-1}(b_i) \times \overline{\text{arc}(a_i, a_{i+1}^-)} \rightarrow \delta^{-1}(b_i) \times \overline{\text{arc}(a_i, a_{i+1}^-)}$$

be an isotopy between  $h_i|_{\gamma^{-1}(b_i)}$  and  $h_{i+1}|_{\gamma^{-1}(b_{i+1}^-)}$  for  $i = 1, \dots, n$ .

Define

$$\beta_i: \gamma^{-1}(b_i) \times \overline{\text{arc}(b_i, b_{i+1}^-)} \rightarrow \delta^{-1}(b_i) \times \overline{\text{arc}(b_i, b_{i+1}^-)}$$

by

$$\beta_i(x, t) = \begin{cases} (h_i(x), t) & \text{if } b_i < t \leq a_i, \\ (F_i(x, t), t) & \text{if } a_i \leq t \leq a_{i+1}^-, \\ (h_{i+1}(x), t) & \text{if } a_{i+1}^- \leq t < b_{i+1}^-, \end{cases}$$

and let  $\alpha_i: \text{Int}(B_i) \rightarrow \text{Int}(B'_i)$  be given by  $\alpha_i = \psi_i^{-1} \circ \beta_i \circ \phi_i$  with  $i = 1, \dots, n$ .

Since each  $\beta_i$  is a diffeomorphism, it follows that  $\alpha_i$  is also a diffeomorphism. Moreover,  $\delta \circ \alpha_i = \gamma$  on  $\text{Int}(B_i)$ , because

$$\delta \circ \alpha_i = \delta \circ \psi_i^{-1} \circ \beta_i \circ \phi_i = \tilde{p} \circ \beta_i \circ \phi_i = p \circ \phi_i = \gamma.$$

We now define a map  $H: S^2 \rightarrow S^2$  given by

$$H(x) = \begin{cases} h_i(x) & \text{if } x \in \text{Int}(A_i), \quad i = 1, \dots, n, \\ \alpha_i(x) & \text{if } x \in \text{Int}(B_i), \quad i = 1, \dots, n. \end{cases}$$

By construction,  $h_i = \alpha_i$  on  $\text{Int}(A_i) \cap \text{Int}(B_i)$  and  $\alpha_i = h_{i+1}$  on  $\text{Int}(B_i) \cap \text{Int}(A_{i+1})$  for all  $i = 1, \dots, n$ . Therefore,  $H$  is well defined and  $C^\infty$ . Moreover,  $H: S^2 \rightarrow S^2$  is a diffeomorphism such that  $\gamma = \delta \circ H$ .  $\square$

Theorems 3.8 and 3.10 together give that the Reeb graph is a complete topological invariant for stable maps from  $S^2$  to  $S^1$ . In fact, we have a little bit more, as we can see in the following corollary.

**Corollary 3.11.** *Let  $\gamma, \delta: S^2 \rightarrow S^1$  be two stable maps. Then the following statements are equivalent:*

- (1)  $\gamma, \delta$  are  $\mathcal{A}$ -equivalent;
- (2)  $\gamma, \delta$  are topologically equivalent;
- (3)  $\Gamma_\gamma \sim \Gamma_\delta$ .

In the last part of this section we consider the Reeb graph of the link of a finitely determined map germ with isolated zeros.

**Remark 3.12.** Let  $f: (\mathbb{R}^3, 0) \rightarrow (\mathbb{R}^2, 0)$  be a finitely determined map germ with  $f^{-1}(0) = \{0\}$  and let  $\gamma_f: \tilde{S}_\varepsilon^2 \rightarrow S_\varepsilon^1$  be the link of  $f$ . The critical values of  $\gamma_f$  are given by  $S_\varepsilon^1 \cap \Delta(f)$ . In fact, if we denote by  $A_1, \dots, A_r$  the half-branches of  $\Delta(f)$ , then by the cone structure theorem each half-branch of  $A_i$  intersects  $S_\varepsilon^1$  at a unique critical value  $v_i$  of  $\gamma_f$ . Analogously, the edges of  $\Gamma_{\gamma_f}$  correspond to the connected components of  $f^{-1}(\alpha_j)$ , where  $\alpha_1, \dots, \alpha_r$  are the arcs of  $S_\varepsilon^1$  limited by two consecutive half-branches of  $\Delta(f)$ .

**Theorem 3.13.** *Let  $f, g: (\mathbb{R}^3, 0) \rightarrow (\mathbb{R}^2, 0)$  be two finitely determined map germs such that  $f^{-1}(0) = \{0\} = g^{-1}(0)$ . If  $f$  and  $g$  are topologically equivalent, then the Reeb graphs of their links are equivalent.*

**Proof.** By hypothesis, there exist two homeomorphism germs  $h, k$  such that the following diagram commutes:

$$\begin{array}{ccc}
 (\mathbb{R}^3, 0) & \xrightarrow{f} & (\mathbb{R}^2, 0) \\
 h \downarrow & & \downarrow k \\
 (\mathbb{R}^3, 0) & \xrightarrow{g} & (\mathbb{R}^2, 0)
 \end{array} \tag{3.1}$$

We take representatives of  $f, g, h$  and  $k$ , and for any small enough  $\varepsilon > 0$  the diagram

$$\begin{array}{ccc}
 \tilde{S}_\varepsilon^2 & \xrightarrow{\gamma_f} & S_\varepsilon^1 \\
 h \downarrow & & \downarrow k \\
 M_\varepsilon & \xrightarrow{g|_{M_\varepsilon}} & P_\varepsilon
 \end{array} \tag{3.2}$$

is also commutative, where  $M_\varepsilon = h(\tilde{S}_\varepsilon^2)$  and  $P_\varepsilon = k(S_\varepsilon^1)$ .

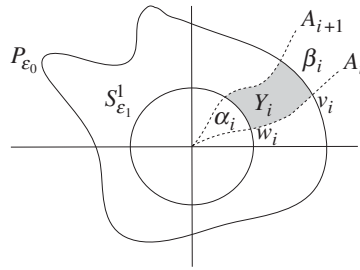

Figure 3. A connected component of  $U$ .

From the commutativity of (3.2), it follows that  $g|M_\epsilon$  is  $C^0$ -stable. Choose  $\epsilon_0, \epsilon_1 > 0$  such that  $\gamma_f: \tilde{S}_{\epsilon_0}^2 \rightarrow S_{\epsilon_0}^1$  and  $\gamma_g: \tilde{S}_{\epsilon_1}^2 \rightarrow S_{\epsilon_1}^1$  are the links of  $f$  and  $g$ , respectively, and  $S_{\epsilon_1}^1 \subset k(D_{\epsilon_0}^2)$ . By Definition 3.9, let  $\Gamma_{g|M_{\epsilon_0}}$  be the Reeb graph associated with  $g|M_{\epsilon_0}$ . Then we can conclude that  $\Gamma_{g|M_{\epsilon_0}}$  is equivalent to  $\Gamma_{\gamma_f}$ , where  $\Gamma_{\gamma_f}$  is the Reeb graph of  $\gamma_f$ .

Consider  $A_1, \dots, A_n$ , the half-branches of the discriminant  $\Delta(g)$ , ordered in the anti-clockwise orientation. By the cone structure of  $f$  (see Theorem 2.4), each half-branch  $A_i$  intersects  $P_{\epsilon_0}$  at a unique point  $v_i$  so that  $v_1, \dots, v_n$  are the critical points of  $g|M_{\epsilon_0}$ . Analogously, each  $A_i$  intersects  $S_{\epsilon_1}^1$  at a unique point  $w_i$ , where  $w_1, \dots, w_n$  are now the critical points of  $\gamma_g$ . We have a graph isomorphism  $l: P_{\epsilon_0} \rightarrow S_{\epsilon_1}^1$  given by  $l(v_i) = w_i$  for all  $i = 1, \dots, n$ .

Let  $C_1, \dots, C_r$  be the connected components of  $g^{-1}(\Delta(g)) - \{0\} = \bigcup_{i=1}^n g^{-1}(A_i)$ . Again by the cone structure of  $f$ , each connected component  $C_j$  intersects  $M_{\epsilon_0}$  in a unique connected component  $V_j$  of some  $g^{-1}(v_i)$  so that  $V_1, \dots, V_r$  are the vertices of  $\Gamma_{g|M_{\epsilon_0}}$ . Finally, each  $C_j$  intersects  $\tilde{S}_{\epsilon_1}^2$  in a unique connected component  $W_j$  of  $g^{-1}(w_i)$  in such a way that  $W_1, \dots, W_r$  are now the vertices of  $\Gamma_{\gamma_g}$ . We have a bijection  $\varphi$  defined by  $\varphi(V_j) = W_j$  for all  $j = 1, \dots, r$ . In order to have a graph isomorphism between  $\Gamma_{g|M_{\epsilon_0}}$  and  $\Gamma_{\gamma_g}$  we need to show that  $\varphi$  is edge preserving.

Consider  $U = k(D_{\epsilon_0}^2) - (\Delta(g) \cup B_{\epsilon_1}^2)$  and let  $Y_i$  be one of its connected components limited by two consecutive half-branches  $A_i$  and  $A_{i+1}$ . We denote by  $\alpha_i$  and  $\beta_i$  the arcs of  $S_{\epsilon_1}^1$  and  $P_{\epsilon_0}$ , respectively, which bound  $Y_i$  for all  $i = 1, \dots, n$  (see Figure 3). As pointed out in Remark 3.12, the connected components of  $g^{-1}(\alpha_i)$  and  $g^{-1}(\beta_i)$  give all the edges of the graphs  $\Gamma_{\gamma_g}$  and  $\Gamma_{g|M_{\epsilon_0}}$ , respectively.

Take  $X$  to be any connected component of  $f^{-1}(Y_i)$  for some  $1 \leq i \leq n$ . Since  $g|X: X \rightarrow Y_i$  is regular, the induced map  $\tilde{g}: X/\sim \rightarrow Y_i$  is a local homeomorphism, and hence a covering space. But  $Y_i$  is simply connected, so  $\tilde{g}$  is in fact a homeomorphism. We deduce that the boundary of  $X/\sim$  has two components: one is an edge of  $\Gamma_{\gamma_g}$  given by the quotient of  $X \cap g^{-1}(\alpha_i)$  and the other is an edge of  $\Gamma_{g|M_{\epsilon_0}}$  given by the quotient of  $X \cap g^{-1}(\beta_i)$ .

Notice that all the edges of  $\Gamma_{\gamma_g}$  and  $\Gamma_{g|M_{\epsilon_0}}$  can be obtained in this way, and hence we have a bijection between the edges of  $\Gamma_{\gamma_g}$  and  $\Gamma_{g|M_{\epsilon_0}}$ , which is compatible with the above bijection  $\varphi$  defined between the vertices.  $\square$

Again, Theorem 3.13 together with Corollary 2.7 and Theorem 3.10 show that the Reeb graph is a complete topological invariant for map germs with isolated zeros.

**Corollary 3.14.** *Let  $f, g: (\mathbb{R}^3, 0) \rightarrow (\mathbb{R}^2, 0)$  be finitely determined map germs such that  $f^{-1}(0) = \{0\} = g^{-1}(0)$ . Then the following statements are equivalent:*

- (1)  $f, g$  are topologically equivalent;
- (2) the Reeb graphs of the links of  $f, g$  are equivalent;
- (3) the links of  $f, g$  are topologically equivalent.

#### 4. Topological classification of corank 1 map germs with $f^{-1}(0) = \{0\}$

Let  $f: (\mathbb{R}^3, 0) \rightarrow (\mathbb{R}^2, 0)$  be a corank 1 finitely determined map germ. After an appropriate change of coordinates in the source and the target, we can write  $f$  as  $f(x, y, z) = (x, h_x(y, z))$ . In other words,  $f$  can be seen as an unfolding of the map germ  $h_0: (\mathbb{R}^2, 0) \rightarrow (\mathbb{R}, 0)$ . In the case in which  $f^{-1}(0) = \{0\}$ , this also implies that  $h_0^{-1}(0) = \{0\}$ .

**Lemma 4.1.** *Let  $f: (\mathbb{R}^3, 0) \rightarrow (\mathbb{R}^2, 0)$  be a corank 1 finitely determined map germ given by  $f(x, y, z) = (x, h_x(y, z))$ . Then  $h_0: (\mathbb{R}^2, 0) \rightarrow (\mathbb{R}, 0)$  is a finitely determined map germ.*

**Proof.** Since  $f$  is finitely determined, we can assume that it is polynomial. Then its complexification  $f_{\mathbb{C}}$  is also finitely determined and by the Mather–Gaffney criterion,  $S(f_{\mathbb{C}}) \cap f_{\mathbb{C}}^{-1}(0) = \{0\}$  (see [24]). This implies that  $S((h_0)_{\mathbb{C}}) \cap (h_0)_{\mathbb{C}}^{-1}(0) = \{0\}$ , and hence  $h_0$  is finitely determined for the contact group  $\mathcal{K}$ . But for function germs it is well known that the finite determinacy with respect to the contact group  $\mathcal{K}$  is equivalent to the finite determinacy with respect to the group  $\mathcal{A}$  (see again [24]).  $\square$

We get a first important consequence of this lemma for the case in which  $f^{-1}(0) = \{0\}$ .

**Theorem 4.2.** *Let  $f: (\mathbb{R}^3, 0) \rightarrow (\mathbb{R}^2, 0)$  be a corank 1 finitely determined map germ with  $f^{-1}(0) = \{0\}$ . Then the associated link of  $f$  is not surjective.*

**Proof.** Consider  $f$  written as  $f(x, y, z) = (x, h_x(y, z))$ , where  $h_0$  is also finitely determined and  $h_0^{-1}(0) = \{0\}$ . By Fukuda’s theorem (Theorem 2.4),  $h_0^{-1}(S_{\varepsilon}^0)$  is diffeomorphic to  $S^1$  for small enough  $\varepsilon > 0$ .

Suppose that the associated link of  $f$  is surjective. Then  $(0, \varepsilon)$  and  $(0, -\varepsilon)$  belong to the image of the map  $\gamma_f: f^{-1}(S_{\varepsilon}^1) \rightarrow S_{\varepsilon}^1$ . But

$$\gamma_f^{-1}(\{(0, \varepsilon), (0, -\varepsilon)\}) = f^{-1}(\{(0, \varepsilon), (0, -\varepsilon)\}) \simeq h_0^{-1}(\{\varepsilon, -\varepsilon\}) \simeq S^1,$$

where  $\simeq$  indicates homeomorphism of sets. This gives a contradiction because  $S^1$  is connected,  $\{(0, \varepsilon), (0, -\varepsilon)\}$  is not connected and  $\gamma_f$  is a continuous map.  $\square$

**Remark 4.3.**

- (1) It follows from Theorem 4.2 that the stable map  $\gamma: S^2 \rightarrow S^1$  presented on the right-hand side of Figure 2 cannot be realized as the link of a corank 1 finitely determined map germ  $f: (\mathbb{R}^3, 0) \rightarrow (\mathbb{R}^2, 0)$ . At this point, we do not know if in fact this stable map can be realized or not as the link of a corank 2 map germ.
- (2) Another consequence of Theorem 4.2 is that if  $f$  has corank 1 and  $f^{-1}(0) = \{0\}$ , then the generalized Reeb graph can be obtained from the classical one since the link is not surjective (see Remark 3.5). From now on in this section, the Reeb graph referred to will be the classical version unless otherwise specified.

Given that  $f(x, y, z) = (x, h_x(y, z))$ , we say that  $f$  is a stabilization of  $h_0$  if there is a representative  $f: U = (-\varepsilon, \varepsilon) \times V \rightarrow \mathbb{R}^2$  such that for any  $x$  with  $0 < |x| < \varepsilon$ ,  $h_x: V \subset \mathbb{R}^2 \rightarrow \mathbb{R}$  is stable (i.e. it is a Morse function with distinct critical values).

**Proposition 4.4.** *Let  $f: (\mathbb{R}^3, 0) \rightarrow (\mathbb{R}^2, 0)$  be a finitely determined map germ given by  $f(x, y, z) = (x, h_x(y, z))$ . Then  $f$  is a stabilization of  $h_0$ .*

**Proof.** By Corollary 2.3, if  $f$  is finitely determined, we can choose a representative  $f: U \subset \mathbb{R}^3 \rightarrow \mathbb{R}^2$  such that  $S(f) \cap f^{-1}(0) = \{0\}$  and the restriction  $f|_{U-\{0\}}$  is stable with only simple definite and indefinite folds. By shrinking  $U$  if necessary, we can assume that  $U = (-\varepsilon, \varepsilon) \times V$ , where  $V$  is a neighbourhood of 0 in  $\mathbb{R}^2$  and  $\varepsilon > 0$ . Let us take  $x_0 \in (-\varepsilon, \varepsilon)$ ,  $x_0 \neq 0$ .

Suppose that  $h_{x_0}$  has a degenerate singularity at  $p \in V$ ; then the Hessian determinant of  $h_{x_0}$  at  $p$  is equal to 0. Since  $p \in S(h_{x_0})$ ,  $(x_0, p) \in S(f)$  and  $(x_0, p)$  is not a fold point of  $f$  in  $U - \{0\}$ . Analogously, if  $h_{x_0}$  is singular at two distinct points  $p_0, p_1 \in V$  such that  $h_{x_0}(p_0) = h_{x_0}(p_1)$ , then  $(x_0, p_0), (x_0, p_1) \in S(f)$  and  $f$  should have a double fold at  $(x_0, p_0), (x_0, p_1) \in U - \{0\}$ . □

Let  $f: (\mathbb{R}^3, 0) \rightarrow (\mathbb{R}^2, 0)$  be a finitely determined map germ given by  $f(x, y, z) = (x, h_x(y, z))$ . We take a representative  $f: U = (-\varepsilon, \varepsilon) \times V \rightarrow \mathbb{R}^2$  such that for any  $x$  with  $0 < |x| < \varepsilon$ ,  $h_x: V \subset \mathbb{R}^2 \rightarrow \mathbb{R}$  is stable. By Lemma 4.1,  $h_0$  has an isolated singularity. By shrinking  $U$  if necessary, we can also assume that  $h_0$  is regular in  $V - \{0\}$ . Moreover, in the case in which  $f$  has an isolated zero, we also impose that  $f^{-1}(0) = \{0\}$  on  $U$ , and hence  $h_0^{-1}(0) = \{0\}$  on  $V$ .

Because of stability, all the functions  $h_x: V \subset \mathbb{R}^2 \rightarrow \mathbb{R}$  are  $\mathcal{A}$ -equivalent if  $-\varepsilon < x < 0$  and we will denote by  $h_x^-$  one of these functions. Analogously, all functions  $h_x: V \subset \mathbb{R}^2 \rightarrow \mathbb{R}$  are  $\mathcal{A}$ -equivalent if  $0 < x < \varepsilon$  and we will denote by  $h_x^+$  one of these functions.

Given a finitely determined map germ  $f: (\mathbb{R}^3, 0) \rightarrow (\mathbb{R}^2, 0)$ , we denote by  $X(f)$  the set germ in  $(\mathbb{R}^3, 0)$  defined by the closure of  $f^{-1}(\Delta(f)) - S(f)$ . By Corollary 2.3, since  $f$  has only folds outside the origin,  $f$  is transverse to  $\Delta(f)$ , and hence  $X(f)$  is a surface outside the origin.

**Lemma 4.5.** *Let  $f: (\mathbb{R}^3, 0) \rightarrow (\mathbb{R}^2, 0)$  be a finitely determined corank 1 map germ given by  $f(x, y, z) = (x, h_x(y, z))$ . Then  $S(f)$ ,  $X(f)$  and  $\Delta(f)$  are transverse to the planes  $\{x\} \times \mathbb{R}^2$  and to the lines  $\{x\} \times \mathbb{R}$ , respectively, with  $0 < |x| < \varepsilon$  and  $\varepsilon$  small enough.*

**Proof.** It follows from Proposition 4.4 that there exists  $\varepsilon > 0$  small enough and  $V \subset \mathbb{R}^2$  an open neighbourhood of 0 such that  $h_x: V \rightarrow \mathbb{R}$  is stable for all  $x$  with  $0 < |x| < \varepsilon$ .

Suppose that  $(x_0, y_0, z_0) \in S(f) \cap \{x_0\} \times \mathbb{R}^2$  and consider a parametrization of  $S(f)$  near  $(x_0, y_0, z_0)$  given by  $\alpha(t) = (x(t), y(t), z(t))$ . We only need to show that  $x'(t) \neq 0$ .

For simplicity we write  $H(x, y, z) = h_x(y, z)$ . Then  $S(f)$  is given by the implicit equations  $\partial H/\partial y = \partial H/\partial z = 0$ . By taking partial derivatives of these equations, we obtain

$$x' \frac{\partial^2 H}{\partial x \partial y} + y' \frac{\partial^2 H}{\partial y^2} + z' \frac{\partial^2 H}{\partial y \partial z} = 0, \quad x' \frac{\partial^2 H}{\partial x \partial z} + y' \frac{\partial^2 H}{\partial y \partial z} + z' \frac{\partial^2 H}{\partial z^2} = 0.$$

If  $x' = 0$ , since  $(y', z') \neq (0, 0)$  we get that

$$\frac{\partial^2 H}{\partial y^2} \frac{\partial^2 H}{\partial z^2} - \left( \frac{\partial^2 H}{\partial y \partial z} \right)^2 = 0.$$

But this is the Hessian of  $h_x$  at the singular point  $(y, z)$ , which contradicts the fact that  $h_x$  is a Morse function.

We note that  $\Delta(f)$  is parametrized by  $f(\alpha(t)) = (x(t), H(x(t), y(t), z(t)))$  near  $f(x_0, y_0, z_0)$ . Since  $x'(t) \neq 0$ , we also have that  $\Delta(f)$  is transverse to  $\{x_0\} \times \mathbb{R}$  at  $f(x_0, y_0, z_0)$ .

Finally, let  $(x_0, y'_0, z'_0) \in X(f) \cap \{x_0\} \times \mathbb{R}^2$  be a point such that  $f(x_0, y_0, z_0) = f(x_0, y'_0, z'_0)$ . Then the transversality between  $X(f)$  and  $\{x_0\} \times \mathbb{R}^2$  is a consequence of the fact that  $f$  is transverse to  $\Delta(f)$  and that  $X(f) = f^{-1}(\Delta(f))$  and  $\{x_0\} \times \mathbb{R}^2 = f^{-1}(\{x_0\} \times \mathbb{R})$  near that point.  $\square$

Let  $f: (\mathbb{R}^3, 0) \rightarrow (\mathbb{R}^2, 0)$  be a corank 1 finitely determined map germ with  $f^{-1}(0) = \{0\}$  given by  $f(x, y, z) = (x, h_x(y, z))$ . By Lemmas 4.1 and 4.5, we consider small enough representatives  $f: (-\varepsilon, \varepsilon) \times V \rightarrow \mathbb{R}^2$  such that for any  $0 < |x| < \varepsilon$ ,  $h_x: V \rightarrow \mathbb{R}$  is stable and, moreover,  $S(f)$ ,  $X(f)$  are transverse to  $\{x\} \times \mathbb{R}^2$ , and  $\Delta(f)$  is transverse to  $\{x\} \times \mathbb{R}$ .

We fix  $x_0 \in \mathbb{R}$  such that  $0 < |x_0| < \varepsilon$  and take  $\delta > 0$  small enough such that  $(h_{x_0})^{-1}([-\delta, \delta]) \subset V$  and  $[-\delta, \delta]$  intersects all the positive (respectively, negative) half-branches of  $\Delta(f)$  if  $x_0 > 0$  (respectively, if  $x_0 < 0$ ).

Consider the following equivalence relation on  $(h_{x_0})^{-1}([-\delta, \delta])$ :  $v \sim w \iff h_{x_0}(v) = h_{x_0}(w)$  with  $v$  and  $w$  in the same connected component of  $h_{x_0}^{-1}(h_{x_0}(v))$ . Then the quotient  $(h_{x_0})^{-1}([-\delta, \delta])/\sim$  has a graph structure whose vertices are

- (1) the connected components of  $h_{x_0}^{-1}(v)$ , where  $v$  is any critical value of  $h_{x_0}$ ;
- (2) the connected components of the boundary of  $(h_{x_0})^{-1}([-\delta, \delta])$ ; this type of vertex will be called the boundary vertex and will be denoted by the symbol  $\circ$ .

Moreover, we denote by  $v_1 < \dots < v_n$  the ordered set of critical values of  $h_{x_0}$  together with the value corresponding to the boundary vertex. We assign to each vertex the label  $i \in \{1, \dots, n\}$  if it has the value  $v_i$ . The graph  $(h_{x_0})^{-1}([-\delta, \delta])/\sim$  together with the labels of the vertices is called the Reeb graph of  $h_{x_0}$ .



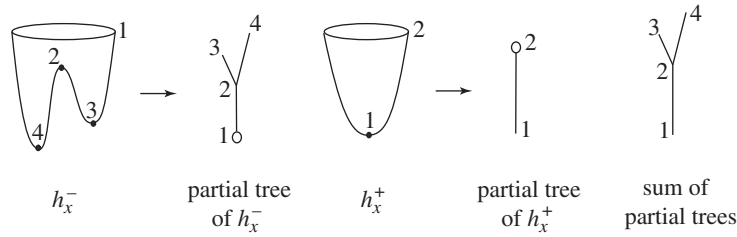

Figure 4. Sum of partial trees.

**Definition 4.6.** We define the *partial tree* of  $h_x^+$  as being the Reeb graph of  $h_{x_0}$  if  $x_0 > 0$ , and we define the *partial tree* of  $h_x^-$  as being the Reeb graph of  $-h_{x_0}$  if  $x_0 < 0$ .

**Example 4.7.** Consider the map germ  $f: (\mathbb{R}^3, 0) \rightarrow (\mathbb{R}^2, 0)$  given by  $f(x, y, z) = (x, h_x(y, z))$ , where  $h_x(y, z) = y^4 + xy^2 + 3x^5 + z^2$ . Here  $h_x$  has three critical values for  $x < 0$ , but only one critical value for  $x > 0$ . The partial trees of  $h_x^+$  and  $h_x^-$  are shown in Figure 4.

We remark that the partial trees  $h_x^+$  and  $h_x^-$  do not depend on of the choice of the representatives, the choice of  $x_0$  or the choice of the interval  $[-\delta, \delta]$ . This follows from the fact that the functions  $h_x: V \rightarrow \mathbb{R}$  are all  $\mathcal{A}$ -equivalent if either  $-\varepsilon < x < 0$  or  $0 < x < \varepsilon$ . Then we can use the same arguments as those of the proof of Theorem 3.8.

Consider the partial trees of  $h_x^+$  and  $h_x^-$ . Assume that  $u_1 < \dots < u_r$  and  $v_1 < \dots < v_s$  are the critical values of  $h_x^+$  and  $h_x^-$ , respectively. Since  $f^{-1}(0) = \{0\}$ , the link  $\gamma_f$  is not surjective and, without loss of generality, we can assume that  $(0, \varepsilon)$  is a regular value that belongs to the image of the link. Consequently,  $u_r$  and  $v_s$  correspond to the boundary vertices of  $h_x^+$  and  $h_x^-$ , respectively.

**Definition 4.8.** Let  $\Gamma_{x>0}$  and  $\Gamma_{x<0}$  be the graphs corresponding to the partial trees of  $h_x^+$  and  $h_x^-$ , respectively. Consider  $\Gamma$ , the graph obtained by connecting the upper edge of  $\Gamma_{x>0} - \{u_r\}$  to the lower edge of  $\Gamma_{x<0} - \{v_s\}$ . We relabel each vertex  $v_{s-i}$  by  $u_{r+(i-1)}$ , where  $i = 1, \dots, s - 1$ . We say that  $\Gamma$  is the *sum of the partial trees of  $h_x^+$  and  $h_x^-$* .

**Remark 4.9.** The sum of the partial trees of the map germ in Example 4.7 is also shown in the right-hand side of Figure 4.

The main result of this section is the following theorem.

**Theorem 4.10.** *Let  $f: (\mathbb{R}^3, 0) \rightarrow (\mathbb{R}^2, 0)$  be a corank 1 finitely determined map germ with  $f^{-1}(0) = \{0\}$  given by  $f(x, y, z) = (x, h_x(y, z))$ . Then the sum of partial trees of  $h_x^+$  and  $h_x^-$  is equivalent to the Reeb graph of the associated link of  $f$ .*

**Proof.** Take  $\varepsilon > \delta > 0$  small enough and  $V \subset \mathbb{R}^2$  a neighbourhood of the origin such that the following four conditions are satisfied:

- (i)  $\gamma_f: \tilde{S}_\delta^2 \rightarrow S_\delta^1$  is the link of  $f$ ;
- (ii) the function  $h_x|_V: V \rightarrow \mathbb{R}$  is stable for all  $x \in (-\varepsilon, \varepsilon)$ ,  $x \neq 0$ ;

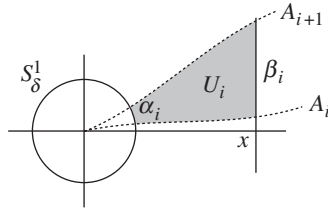

Figure 5. The set  $U_i$ .

- (iii)  $\{x\} \times V$  intercepts all half-branches of  $S(f)$  with the same sign of  $x$ ;
- (iv)  $\tilde{S}_\delta^2 \subset (-\varepsilon, \varepsilon) \times V$ ;
- (v)  $h_0^{-1}(0) = \{0\}$  and  $h_0$  is regular on  $V - \{0\}$ .

We have from (v) that  $S(f) \cap (\{0\} \times \mathbb{R}^2) = \{0\}$  and  $\Delta(f) \cap (\{0\} \times \mathbb{R}) = \{0\}$ . Hence,  $(0, \delta)$  and  $(0, -\delta)$  are regular values of  $\gamma_f: \tilde{S}_\delta^2 \rightarrow S_\delta^1$ . Moreover, since the link of  $f$  is not surjective, just one of the points  $(0, -\delta)$ ,  $(0, \delta)$  belongs to the image of the link. We assume here that  $(0, \delta) \in \text{Im}(\gamma_f)$ .

Let  $A_1, \dots, A_n$  be the half-branches of  $\Delta(f)$  considered in the anti-clockwise orientation and such that  $(0, -\delta)$  is the base point. We also assume that  $A_1, \dots, A_r$  are on the half-plane  $x > 0$  and that  $A_{r+1}, \dots, A_n$  are on the half-plane  $x < 0$ .

By the cone structure of  $f$ , each half-branch  $A_i$  intersects  $S_\delta^1$  at a unique point  $v_i$ , so that  $v_1 < \dots < v_n$  are the critical points of  $\gamma_f$  in the chosen orientation. By the transversality of  $\Delta(f)$  to the vertical lines  $\{x\} \times \{\mathbb{R}\}$ , given that  $\delta < x < \varepsilon$  we have that each half-branch  $A_i$  also intersects  $\{x\} \times \{\mathbb{R}\}$  at a unique point  $w_i$ . But now  $w_1 < \dots < w_r$  are the critical values of  $h_x^+$  and  $w_n < \dots < w_{r+1}$  are the critical values of  $h_x^-$ .

Since we are considering the classical version of the Reeb graph, each critical value corresponds to a unique vertex. Thus, there is a bijection given by  $\varphi(v_i) = w_i$  for  $i \in \{1, \dots, n\}$  between the vertices of  $\Gamma_{\gamma_f}$  and the vertices of  $\Gamma$ , the sum of the partial trees of  $h_x^+$  and  $h_x^-$ . Moreover, the bijection is compatible with the labels of the vertices as defined in Definition 4.8.

To finish the proof, we only need to show that there is also a bijection between the edges compatible with  $\varphi$ . Consider the following sets (Figure 5):

- $U_i$ , the set of points limited by  $A_i, A_{i+1}, S_\delta^1$  and  $\{x\} \times \mathbb{R}$ ;
- $\alpha_i$ , the arc of  $S_\delta^1$  limited by  $A_i$  and  $A_{i+1}$ ;
- $\beta_i$ , the line segment of  $\{x\} \times \mathbb{R}$  limited by  $A_i$  and  $A_{i+1}$ ;
- $Y_i = U_i \cup \alpha_i \cup \beta_i$ ;

with  $\delta < x < \varepsilon$  if  $1 \leq i < r$  and  $-\varepsilon < x < -\delta$  if  $r + 1 \leq i < n$ .

Each one of the connected components of  $f^{-1}(\alpha_i)$  and  $f^{-1}(\beta_i)$  gives an edge for the graphs  $\Gamma_{\gamma_f}$  and  $\Gamma$ , respectively.

Let  $X$  be any connected component of  $f^{-1}(Y_i)$ . Notice that  $f|_X: X \rightarrow Y_i$  is regular. So, the induced map  $\tilde{f}: X/\sim \rightarrow Y_i$  is a local homeomorphism, and hence a covering map.

Since  $Y_i$  is simply connected and  $X$  is connected, we have that  $\tilde{f}$  is a homeomorphism. Hence,  $X/\sim$  contains only one edge of  $\Gamma_{\gamma_f}$  corresponding to  $X \cap f^{-1}(\alpha_i)$ , and also only one edge of  $\Gamma$  corresponding to  $X \cap f^{-1}(\beta_i)$ .

Moreover, since  $f^{-1}(0, \delta)$  is diffeomorphic to  $S^1$ , the arc of  $S^1_\delta$  delimited by  $A_s$  and  $A_{s+1}$  corresponds to a unique edge of  $\Gamma_{\gamma_f}$ . We associate this edge with the edge of  $\Gamma$  used to join the partial trees of  $h_x^+$  and  $h_x^-$ .

In this way, we can define a bijection  $\phi$  between the edges of  $\Gamma_{\gamma_f}$  and the edges of  $\Gamma$ , which is compatible with  $\varphi$ . Hence, the graphs  $\Gamma_{\gamma_f}$  and  $\Gamma$  are equivalent. □

#### 4.1. Classification of germs with Boardman symbol $\Sigma^{2,1}$

Next, we state a result due to Rieger and Ruas [21] that gives a classification of corank 1 map germs according to its 2-jet. We denote by  $\Sigma^1 J^2(3, 2)$  the space of 2-jets of corank 1 map germs from  $(\mathbb{R}^3, 0)$  to  $(\mathbb{R}^2, 0)$  and  $\mathcal{A}^2$  denotes the space of 2-jets of diffeomorphisms in the source and target.

**Lemma 4.11.** *There exist the following orbits in  $\Sigma^1 J^2(3, 2)$  under the action of  $\mathcal{A}^2$ :*

$$(x, y^2 + z^2), \quad (x, y^2 - z^2), \quad (x, xy + z^2), \quad (x, xy - z^2), \quad (x, z^2), \quad (x, 0).$$

The germ  $f(x, y, z) = (x, y^2 \pm z^2)$  is 2- $\mathcal{A}$ -determined. Thus, if a map germ has a 2-jet equivalent to  $(x, y^2 \pm z^2)$ , then it is in fact  $\mathcal{A}$ -equivalent to the definite or indefinite fold. Hence, we do not need to consider this case. The orbits distinct from  $(x, 0)$  have Boardman symbol  $\Sigma^{2,1}$ .

Now, we centre our attention on corank 1 finitely determined map germs  $f: (\mathbb{R}^3, 0) \rightarrow (\mathbb{R}^2, 0)$  with  $f^{-1}(0) = \{0\}$  and Boardman symbol  $\Sigma^{2,1}$ . By the splitting lemma [21], we can choose coordinates in the source and the target such that  $f$  is given by  $f(x, y, z) = (x, \tilde{h}_x(y) + z^2)$ . Moreover,  $\tilde{h}_0$  is  $\mathcal{A}$ -equivalent to  $y^k$ , for some  $k$  even, and by using the versal unfolding of  $y^k$  we can assume that

$$\tilde{h}_x(y) = y^k + a_{k-2}(x)y^{k-2} + \dots + a_1(x)y.$$

Notice that  $k$  is the multiplicity of  $\tilde{h}_0$ .

We want to construct the partial trees of  $h_x^+$  and  $h_x^-$ , where  $h_x(y, z) = \tilde{h}_x(y) + z^2$ .

The Jacobian and Hessian matrices of  $h_x(y, z)$  are, respectively,

$$J = \begin{pmatrix} \tilde{h}'_x(y) & 2z \end{pmatrix}, \quad H = \begin{pmatrix} \tilde{h}''_x(y) & 0 \\ 0 & 2 \end{pmatrix}.$$

Hence, the critical points of  $h_x$  are those of the form  $(y, 0)$ , where  $y$  is a critical point of  $\tilde{h}_x$ . Moreover,  $(y, 0)$  is a saddle point of  $h_x$  if and only if  $y$  is a maximum of  $\tilde{h}_x$ , and  $(y, 0)$  is a maximum or minimum of  $h_x$  if and only if  $y$  is a minimum of  $\tilde{h}_x$ .

**Example 4.12.** Let  $f: (\mathbb{R}^3, 0) \rightarrow (\mathbb{R}^2, 0)$  be a corank 1 finitely determined map germ with  $f^{-1}(0) = \{0\}$ , with Boardman symbol  $\Sigma^{2,1}$  and with multiplicity 4. After change of coordinates in the source and target, we can assume that  $f$  is given by

$$f(x, y, z) = (x, y^4 + a(x)y^2 + b(x)y + z^2).$$

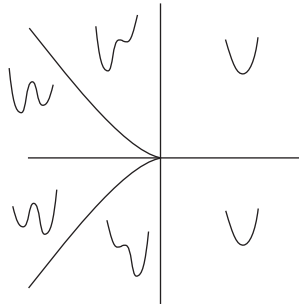

Figure 6. Bifurcation set of  $y^4$ .

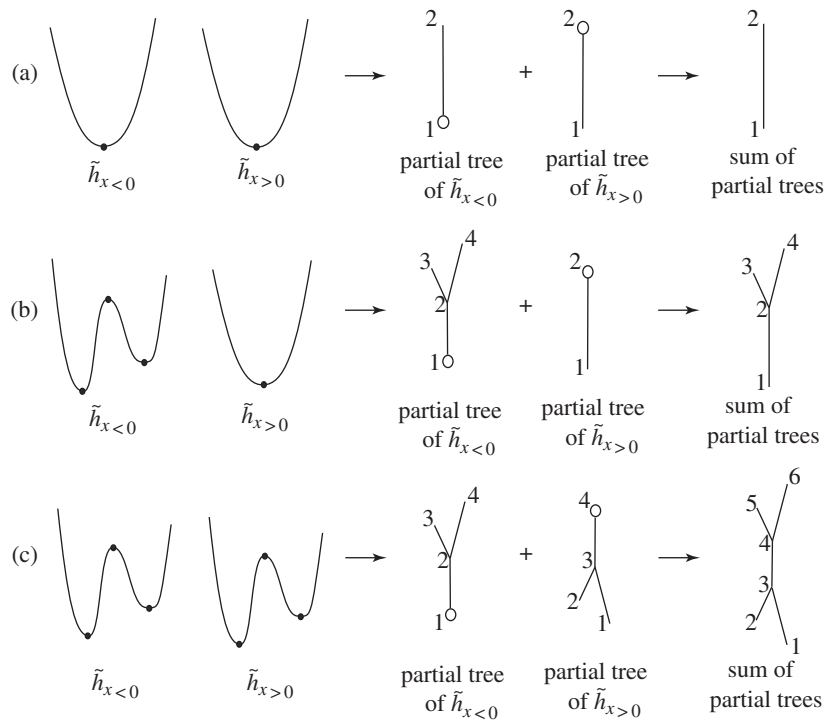

Figure 7. Sum of partial trees in Example 4.12.



Figure 8. Possibilities for  $\tilde{h}$ .

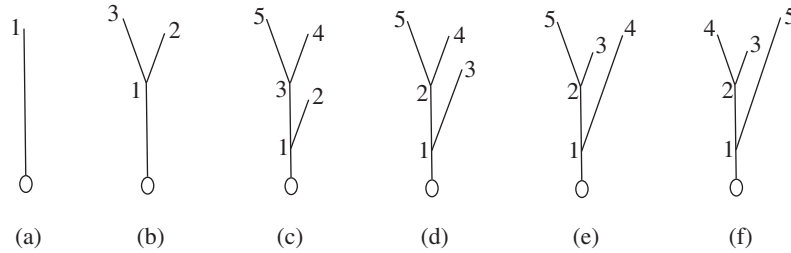

Figure 9. Partial trees.

Notice that the bifurcation set  $\mathcal{B}$  of the versal unfolding of  $h_0$  in this case is given in the  $(a, b)$ -plane by  $b(-4a^3b - 27b^3) = 0$  (see Figure 6), which permits us to choose appropriate functions  $a(x)$  and  $b(x)$  such that we can obtain all possible types of tree.

Then there are three possibilities for the Reeb graph of the link of  $f$ , according to the number of saddles.

- Zero saddles:  $f$  is topologically equivalent to  $(x, y^4 + x^2y + z^2)$  (see Figure 7 (a)).
- One saddle:  $f$  is topologically equivalent to  $(x, y^4 + xy^2 + 3x^5y + z^2)$  (see Figure 7 (b)).
- Two saddles:  $f$  is topologically equivalent to  $(x, y^4 - x^2y^2 + x^5y + z^2)$  (see Figure 7 (c)).

**Theorem 4.13.** *Let  $f: (\mathbb{R}^3, 0) \rightarrow (\mathbb{R}^2, 0)$  be a corank 1 finitely determined map germ,  $f^{-1}(0) = \{0\}$  with Boardman symbol  $\Sigma^{2,1}$  and with multiplicity less than or equal to 6. Then all the possibilities for the Reeb graph of the link of  $f$  are realized and are presented in Table 1.*

**Proof.** Assume that  $f$  is given by

$$f(x, y) = (x, y^6 + a(x)y^4 + b(x)y^3 + c(x)y^2 + d(x)y + z^2).$$

Notice that  $\tilde{h}_x$  may have zero, one or two saddles, as shown in Figure 8.

All the possibilities for the partial trees of the link of  $f$  are given in Figure 9.

In this way, all the Reeb graphs of the link of  $f$  can be obtained by taking all possible combinations among these six models of partial trees. Note that (a) + (a) is equivalent to the Reeb graph of  $(x, y^2 + z^2)$ ; (a) + (b) and (b) + (b) are equivalent to the Reeb graphs given in Example 4.12. □

### Appendix A. Morse functions and cobordism

In this appendix we describe some results about Morse function theory and cobordism theory given by Arnold, Milnor and Izar (see [1, 8–10, 13]). We adopt the notation and basic definitions that are usual in Morse theory and cobordism theory. The reader can use [12, 13] as basic references.

Table 1. Classification of map germs with multiplicity less than or equal to 6.

germ	associated tree
$(x, y^2 + z^2)$	
$(x, y^4 + xy^2 + 3x^5y + z^2)$	
$(x, y^4 - x^2y^2 + x^5y + z^2)$	
$(x, y^6 + 2xy^4 + x^2y^2 + x^4y + z^2)$	
$(x, y^6 + 2xy^4 + x^3y^3 - x^2y^3 - x^4y^2 + \frac{5}{4}x^2y^2 + x^4y + z^2)$	
$(x, y^6 + xy^4 + x^3y^3 + x^4y^2 + x^7y + z^2)$	
$(x, y^6 + x^3y^4 + \frac{1}{9}xy^4 + x^3y^3 + \frac{1}{9}x^4y^2 + x^6y + z^2)$	
$(x, y^6 - \frac{3}{10}x^2y^4 - \frac{1}{15}x^3y^3 - \frac{1}{2}x^5y^2 - \frac{1}{5}x^6y + z^2)$	

Table 1. (Cont.)

germ	associated tree
$(x, y^6 + 6x^3y^4 + 9x^6y^2 + 9x^9y + z^2)$	
$(x, y^6 - 4x^2y^4 + x^4y^3 - 3x^5y^2 + z^2)$	
$(x, y^6 - 6x^2y^4 + xy^4 + x^4y^3 - 6x^3y^2 - 6x^6y + z^2)$	
$(x, y^6 - 4x^4y^4 + 4x^8y^2 - 2x^{10}y + z^2)$	
$(x, y^6 - \frac{93}{20}x^4y^4 + 4x^8y^2 - 2x^{10}y + z^2)$	
$(x, y^6 + \frac{1}{2}xy^5 + \frac{1}{16}x^2y^4 + \frac{1}{12}x^4y^3 - \frac{1}{8}x^7y^2 + z^2)$	
$(x, y^6 - \frac{1}{10}xy^5 - \frac{23}{40}x^3y^4 - \frac{35}{32}x^5y^3 - \frac{441}{640}x^7y^2 + z^2)$	

Table 1. (Cont.)

germ	associated tree
$(x, y^6 - x^2y^4 + x^4y^3 + x^6y^2 + z^2)$	
$(x, y^6 + \frac{1}{45}x^2y^4 - \frac{1}{15}x^4y^3 - \frac{1}{20}x^6y^2 + \frac{1}{15}x^9y + z^2)$	
$(x, y^6 - \frac{3}{6}x^2y^4 + \frac{1}{3}x^5y^3 + 3x^6y^2 - x^9y + z^2)$	
$(x, y^6 - 6x^2y^5 - \frac{4}{5}xy^5 + 4x^3y^4 - 5x^8y^3 + 15x^8y^2 + z^2)$	
$(x, y^6 + 6xy^5 + 16x^3y^4 + 14x^5y^3 + 4x^7y^2 + z^2)$	
$(x, y^6 - \frac{27}{10}xy^5 - \frac{9}{5}x^3y^4 + \frac{33}{160}x^5y^3 + \frac{81}{320}x^7y^2 + \frac{81}{80}x^{10}y + z^2)$	

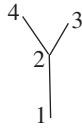
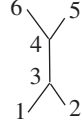
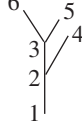
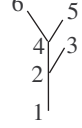
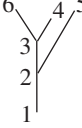
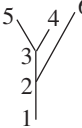
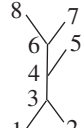
**Definition A 1.** We say that  $(M; V_0, V_1)$  is a *triad* if  $M$  is a  $C^\infty$  compact manifold with boundary and  $\partial M$  is the disjoint union of two closed submanifolds  $V_0$  and  $V_1$  (see Figure 10).

**Definition A 2.** A *Morse function on a triad*  $(M; V_0, V_1)$  is a  $C^\infty$  function  $f: M \rightarrow [a, b]$  such that



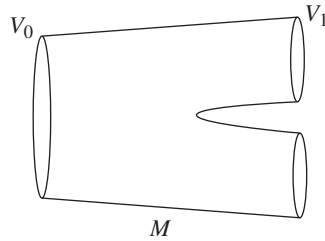

Figure 10. Cobordism.

- (i)  $f^{-1}(a) = V_0$  and  $f^{-1}(b) = V_1$ ,
- (ii) all critical points of  $f$  are interior (lie in  $M - \partial M$ ) and non-degenerated,
- (iii)  $f$  is injective when restricted to the set of its critical points.

Roughly speaking, by using Morse functions it is possible to express any complicated cobordism as a composition of simpler cobordisms.

**Theorem A 3 (Milnor [13]).** *For every Morse function  $f$  on a triad  $(M; V_0, V_1)$ , there exists a gradient-like vector field  $\xi$  for  $f$ .*

**Theorem A 4 (Milnor [13]).** *If a triad  $(M; V_0, V_1)$  admits a function without critical points, then it is a product cobordism, i.e. it is diffeomorphic to the triad  $(V_0 \times [0, 1], V_0 \times \{0\}, V_0 \times \{1\})$ .*

**Corollary A 5.** *If  $f_i: (M_i; V_i, V'_i) \rightarrow ([0, 1], \{0\}, \{1\})$ ,  $i = 0, 1$ , are Morse functions without critical points and if  $V_0$  is diffeomorphic to  $V_1$ , then there exists a diffeomorphism  $h: M_0 \rightarrow M_1$  such that  $f_0 = f_1 \circ h$ .*

**Definition A 6 (characteristic embedding; see [13]).** Let  $(M; V_0, V_1)$  be a triad with a Morse function  $f: M \rightarrow \mathbb{R}$  and a gradient-like vector field  $\xi$  for  $f$ . Suppose that  $p \in M$  is a critical point of  $f$  and let  $V_0 = f^{-1}(c_0)$  and  $V_1 = f^{-1}(c_1)$  be the levels such that  $c_0 < c = f(p) < c_1$ , where  $c$  is the unique critical value of  $f$  in  $[c_0, c_1]$ .

Since  $\xi$  is a gradient-like vector field for  $f$ , there exists a neighbourhood  $U$  of  $p$  in  $M$  and a parametrization  $\alpha: B_{2\varepsilon}^n \rightarrow U$  such that  $f \circ \alpha(x, y) = f(p) - \|x\|^2 + \|y\|^2$  and such that  $\xi$  has coordinates  $(-x, y)$  through  $U$ , where  $x = (x_1, \dots, x_\lambda)$ ,  $y = (x_{\lambda+1}, \dots, x_n)$  for some  $0 \leq \lambda \leq n$  and  $\varepsilon > 0$ . Set  $V_\varepsilon = f^{-1}(c + \varepsilon^2)$  and  $V_{-\varepsilon} = f^{-1}(c - \varepsilon^2)$ . We may assume that  $4\varepsilon^2 < \min\{|c - c_0|, |c - c_1|\}$  so that  $V_{-\varepsilon}$  lies between  $V_0$  and  $f^{-1}(c)$ , and  $V_\varepsilon$  lies between  $f^{-1}(c)$  and  $V_1$ . The situation is represented schematically in Figure 11.

The *left characteristic embedding* of  $p$  is a map  $\phi_L: S^{\lambda-1} \times B^{n-\lambda} \rightarrow V_0$  obtained as follows. First define an embedding  $\phi: S^{\lambda-1} \times B^{n-\lambda} \rightarrow V_{-\varepsilon}$  by

$$\phi(u, \theta v) = \alpha(\varepsilon u \cosh(\theta), \varepsilon v \sinh(\theta)), \quad u \in S^{\lambda-1}, v \in S^{n-\lambda-1}, 0 \leq \theta < 1.$$

Starting at the point  $\phi(u, \theta v)$  in  $V_{-\varepsilon}$ , the integral curve of  $\xi$  is a non-singular curve that leads from  $\phi(u, \theta v)$  back to some well-defined point  $\phi_L(u, \theta v)$  in  $V_0$ . Define the left-hand sphere  $S_L$  of  $p$  in  $V_0$  to be the image  $\phi_L(S^{\lambda-1} \times \{0\})$ . Notice that  $S_L$  is just the intersection

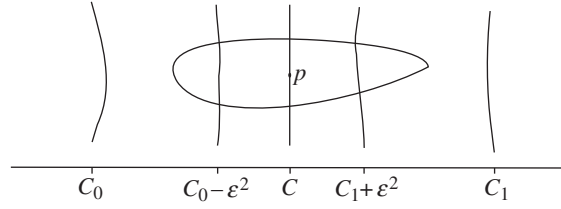

Figure 11. Neighbourhood of a critical point  $p$ .

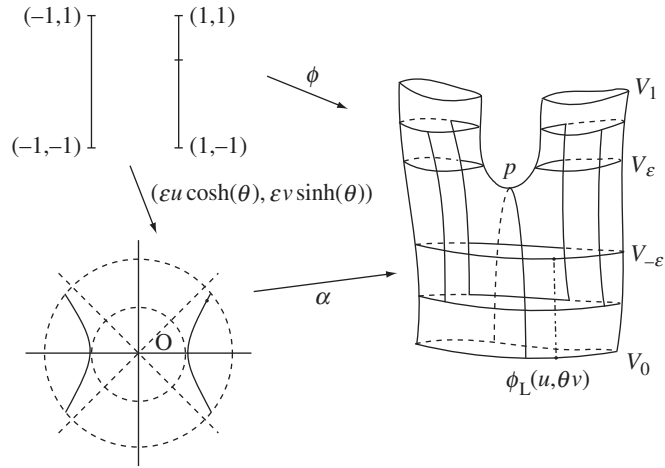

Figure 12. Characteristic embedding.

of  $V_0$  with all integral curves of  $\xi$  leading to the critical point  $p$ . The left-hand disc  $D_L$  is a smoothly embedded disc with boundary  $S_L$ , defined to be the union of all segments of these integral curves beginning in  $S_L$  and ending at  $p$  (see Figure 12).

Similarly, the *right characteristic embedding*  $\phi_R: B^\lambda \times S^{n-\lambda-1} \rightarrow V_1$  is obtained by defining the embedding  $\phi: B^\lambda \times S^{n-\lambda-1} \rightarrow V_\epsilon$  by

$$(\theta u, v) \mapsto \alpha(\epsilon u \sinh(\theta), \epsilon v \cosh(\theta)),$$

and then translating the image to  $V_1$ . The right-hand sphere  $S_R$  of  $p$  in  $V_1$  is defined to be  $\phi_R(\{0\} \times S^{n-\lambda-1})$ . It is the boundary of the right-hand disc  $D_R$ , defined as the union of the segments of integral curves of  $\xi$  beginning at  $p$  and ending in  $S_R$ .

**Definition A 7 (surgery; see [13]).** Given a manifold  $V$  of dimension  $n - 1$  and an embedding  $\phi: S^{\lambda-1} \times B^{n-\lambda} \rightarrow V$ , let  $\chi(V, \phi)$  denote the quotient manifold obtained from the disjoint sum

$$(V - \phi(S^{\lambda-1} \times \{0\})) + (B^\lambda \times S^{n-\lambda-1})$$

by identifying  $\phi(u, \theta v)$  with  $(\theta u, v)$  for each  $u \in S^{\lambda-1}$ ,  $v \in S^{n-\lambda-1}$ ,  $0 < \theta < 1$ . If  $V'$  denotes any manifold diffeomorphic to  $\chi(V, \phi)$ , then we will say that  $V'$  can be obtained from  $V$  by *surgery of type*  $(\lambda, n - \lambda)$ .

It is not hard to prove the next technical result.

**Lemma A 8.**

- (i) If  $V$  is an  $(n - 1)$ -manifold, a surgery of type  $(0, n)$  gives a disjoint union of  $V$  with a sphere  $S^{n-1}$ .
- (ii) A surgery of type  $(n, 0)$  over an  $(n - 1)$ -sphere gives the empty set.
- (iii) A surgery of type  $(1, 1)$  over  $S^1$  gives either two disjoint copies of  $S^1$  or just one copy of  $S^1$ .
- (iv) A surgery of type  $(1, 1)$  over two copies of  $S^1$  gives either one, two or three copies of  $S^1$ .

**Definition A 9.** An elementary cobordism is a triad  $(M; V_0, V_1)$  possessing a Morse function  $f$  with exactly one critical point.

**Theorem A 10 (Milnor [13]).** If  $V_1 = \chi(V_0, \phi)$  can be obtained from  $V_0$  by surgery of type  $(\lambda, n - \lambda)$ , then there exists an elementary cobordism  $(M; V_0, V_1)$  and a Morse function  $f: M \rightarrow \mathbb{R}$  with exactly one critical point, of index  $\lambda$ .

Let  $L_\lambda$  denote the smooth manifold with boundary of points  $(x, y) \in \mathbb{R}^\lambda \times \mathbb{R}^{n-\lambda} = \mathbb{R}^n$  that satisfy the inequalities  $-1 \leq -\|x\|^2 + \|y\|^2 \leq 1$  and  $\|x\|\|y\| < (\sinh 1)(\cosh 1)$ .

**Definition A 11.** With the notation of Theorem A 10, we define  $\omega(V_0, \phi)$ , the quotient manifold obtained from the disjoint sum

$$(V_0 - \phi(S^{\lambda-1} \times \{0\})) \times \bar{B}^1 + L_\lambda,$$

by the following identification: for each  $u \in S^{\lambda-1}$ ,  $v \in S^{n-\lambda-1}$  and  $0 < \theta < 1$ , identify the point  $(\phi(u, \theta v), c)$  in the first summand with the unique point  $(x, y) \in L_\lambda$  such that

- (1)  $-\|x\|^2 + \|y\|^2 = c$ ,
- (2)  $(x, y)$  lies on the orthogonal trajectory that passes through  $(u \sinh \theta, v \sinh \theta)$ .

It is not difficult to see that  $\omega(V_0, \phi)$  is well defined and is a smooth manifold with boundary.

**Theorem A 12 (Milnor [13]).** Let  $(M; V_0, V_1)$  be an elementary cobordism with characteristic embedding  $\phi_L: S^{\lambda-1} \times B^{n-\lambda} \rightarrow V_0$ . Then  $(M; V_0, V_1)$  is diffeomorphic to the triad  $(\omega(V_0, \phi_L); V_0, \chi(V_0, \phi_L))$ .

The next lemma follows from Theorems A 10 and A 12.

**Lemma A 13 (Izar [8]).** Let  $(M; V_0, V_1)$  be an elementary cobordism with Morse function  $f: M \rightarrow \mathbb{R}$  and characteristic embedding  $\phi_L: S^{\lambda-1} \times B^{n-\lambda} \rightarrow V_0$ . If  $k: \omega(V_0, \phi) \rightarrow M$  is the diffeomorphism of Theorem A 12 and  $g: \omega(V_0, \phi) \rightarrow \mathbb{R}$  is the Morse function on  $\omega(V_0, \phi_L)$  of Theorem A 10, then  $g = f \circ k$ .

**Theorem A 14 (Izar [9]).** *Let  $(M; V_0, V_1)$  and  $(M'; V'_0, V'_1)$  be two triads with Morse functions  $f: M \rightarrow [c_0, c_1]$  and  $g: M' \rightarrow [c_0, c_1]$ , where  $M$  and  $M'$  are compact 2-manifolds. Suppose that:*

- (1)  $f, g$  have a unique critical value  $c$ , with  $c_0 < c < c_1$ ;
- (2)  $f, g$  have a unique critical point  $p \in f^{-1}(c)$  and  $q \in g^{-1}(c)$  such that the index of  $f$  at  $p$  is equal to the index of  $g$  at  $q$ ;
- (3) the level curves  $f^{-1}(c_i)$  and  $g^{-1}(c_i)$ ,  $i = 0, 1$ , have the same topological type.

Then there exists a diffeomorphism  $h: M \rightarrow M'$  such that  $f = g \circ h$ .

**Proof.** Without loss of generality, we can assume that  $M$  and  $M'$  are connected. Notice that outside the connected component that contains the critical point,  $M$  and  $M'$  are product cobordisms. Since the index of  $f$  at  $p$  is equal to the index of  $g$  at  $q$ , and since the level curves  $f^{-1}(c_i)$  and  $g^{-1}(c_i)$ ,  $i = 0, 1$ , have the same topological type, we see from Lemma A 8 that these product cobordisms have the same number of connected components. By Corollary A 5, there exists a diffeomorphism between these product cobordisms conjugating the functions  $f$  and  $g$ .

Thus,  $(M; V_0, V_1)$  is a triad with Morse function  $f: M \rightarrow [c_0, c_1]$  with gradient-like vector field  $\xi$ . There exist a neighbourhood of  $p$  and a parametrization  $\alpha: B_{2\varepsilon}^2 \rightarrow U$  such that  $f(\alpha(x, y)) = c - \|x\|^2 + \|y\|^2$ . Let  $V_{-\varepsilon} = f^{-1}(c - \varepsilon^2)$ ,  $V_\varepsilon = f^{-1}(c + \varepsilon^2)$  and consider the characteristic embedding  $\phi: S^{\lambda-1} \times B^{2-\lambda} \rightarrow V_{-\varepsilon}$ ,  $\phi(u, \theta v) = \alpha(\varepsilon u \cosh(\theta), \varepsilon v \sinh(\theta))$ . By Theorem A 12, there exists a diffeomorphism  $\ell$  between  $(M_\varepsilon; V_{-\varepsilon}, V_\varepsilon)$  and  $(\omega(V_{-\varepsilon}, \phi); V_{-\varepsilon}, \chi(V_{-\varepsilon}, \phi))$ .

Analogously for  $(M'; V'_0, V'_1)$ , by taking the same  $\varepsilon$ , there exists a parametrization  $\beta$  and an embedding  $\phi'(u, \theta v) = \beta(\varepsilon u \cosh(\theta), \varepsilon v \sinh(\theta))$ . Again by Theorem A 12, we have a diffeomorphism  $\ell'$  between  $(M'_\varepsilon; V'_{-\varepsilon}, V'_\varepsilon)$  and  $(\omega(V'_{-\varepsilon}, \phi'); V'_{-\varepsilon}, \chi(V'_{-\varepsilon}, \phi'))$ .

Let  $k$  be a diffeomorphism from  $V_{-\varepsilon}$  to  $V'_{-\varepsilon}$  that preserves the orientation of  $S^1$  and such that  $k \circ \phi = \phi'$ . Then

$$(\omega(V'_{-\varepsilon}, \phi'); V'_{-\varepsilon}, \chi(V'_{-\varepsilon}, \phi')) = (\omega(k(V_{-\varepsilon}), k \circ \phi); k(V_{-\varepsilon}), \chi(k(V_{-\varepsilon}), k \circ \phi)),$$

which also is diffeomorphic to  $(\omega(V_{-\varepsilon}, \phi); V_{-\varepsilon}, \chi(V_{-\varepsilon}, \phi))$ . In fact, the diffeomorphism

$$H = (k \times \text{id}_{\bar{B}^1}) + \text{id}_{L_\lambda}: (V_{-\varepsilon} - \phi(S^{\lambda-1} \times \{0\})) \times \bar{B}^1 + L_\lambda \rightarrow (V'_{-\varepsilon} - \phi'(S^{\lambda-1} \times \{0\})) \times \bar{B}^1 + L_\lambda$$

is compatible with the following equivalence relation: if  $(\phi(u, \theta v), c) \sim (x, y)$ , then  $-\|x\|^2 + \|y\|^2 = c$  and  $(x, y)$  is in the orthogonal trajectory passing through  $(u \cosh(\theta), v \sinh(\theta))$ , but this implies that  $(k \circ \phi(u, \theta v), c) \sim (x, y)$ . The induced map  $\bar{H}$  gives a diffeomorphism between  $(\omega(V_{-\varepsilon}, \phi); V_{-\varepsilon}, \chi(V_{-\varepsilon}, \phi))$  and  $(\omega(V'_{-\varepsilon}, \phi'); V'_{-\varepsilon}, \chi(V'_{-\varepsilon}, \phi'))$ .

We have the diagram

$$\begin{array}{ccc} \omega(V'_{-\varepsilon}, \phi') & \xrightarrow{\ell'} & M'_\varepsilon \xrightarrow{g} [c_0, c_1] \\ \uparrow H & & \uparrow h_1 \nearrow f \\ \omega(V_{-\varepsilon}, \phi) & \xrightarrow{\ell} & M_\varepsilon \end{array}$$

where  $\bar{H}$  conjugates the functions  $f \circ \ell$  and  $g \circ \ell'$ , since  $H$  is the identity function on  $L_\lambda$  and preserves the levels in  $(V \setminus \phi(S^{\lambda-1} \times \{0\})) \times \bar{B}^1$ . Then we obtain a diffeomorphism  $h_1: M_\varepsilon \rightarrow M'_\varepsilon$  conjugating  $f$  and  $g$ . By Lemma A 13,  $h_1$  can be extended to a diffeomorphism  $h: M \rightarrow M'$  such that  $f = g \circ h$ .  $\square$

**Acknowledgements.** The authors thank the referee for helpful comments and suggestions.

E.B.B. and J.J.N.-B. were partly supported by CAPES-PVE Grant 88881.062217/2014-01. J.C.F.C. was partly supported by CAPES and FAPESP. J.J.N.-B. was partly supported by DGICYT Grant MTM2012-33073.

## References

1. V. I. ARNOLD, Topological classification of Morse functions and generalisations of Hilbert's 16th problem, *Math. Phys. Analysis Geom.* **10** (2007), 227–236.
2. E. B. BATISTA, J. C. F. COSTA AND J. J. NUÑO-BALLESTEROS, The Reeb graph of a map germ from  $\mathbb{R}^3$  to  $\mathbb{R}^2$  with non isolated zeros, Preprint (available at [www.uv.es/nuno/Preprints/Reeb2.pdf](http://www.uv.es/nuno/Preprints/Reeb2.pdf); 2015).
3. J. C. F. COSTA AND J. J. NUÑO-BALLESTEROS, Topological  $\mathcal{K}$ -classification of finitely determined map germs, *Geom. Dedicata* **166** (2013), 147–162.
4. C. EHRESMANN, Les connexions infinitésimales dans un espace fibré différentiable, in *Colloque de topologie: Bruxelles, 1950*, Publications du Centre Belge de Recherches Mathématiques, pp. 29–55 (G. Thone, Liège, 1951).
5. T. FUKUDA, Local topological properties of differentiable mappings, I, *Invent. Math.* **65**(2) (1981), 227–250.
6. T. FUKUDA, Local topological properties of differentiable mappings, II, *Tokyo J. Math.* **8**(2) (1985), 501–520.
7. M. GOLUBITSKY AND V. GUILLEMIN, *Stable mappings and their singularities*, Graduate Texts in Mathematics, Volume 14 (Springer, 1973).
8. S. A. IZAR, Funções de Morse e topologia das superfícies I: O grafo de Reeb de  $f: M \rightarrow \mathbb{R}$ , *Métrica* no. 31 (1988), 1–32 (available at [www.ibilce.unesp.br/Home/Departamentos/Matematica/metrica-31.pdf](http://www.ibilce.unesp.br/Home/Departamentos/Matematica/metrica-31.pdf)).
9. S. A. IZAR, Funções de Morse e topologia das superfícies II: Classificação das funções de Morse estáveis sobre superfícies, *Métrica* no. 35 (1989), 1–28 (available at [www.ibilce.unesp.br/Home/Departamentos/Matematica/metrica-35.pdf](http://www.ibilce.unesp.br/Home/Departamentos/Matematica/metrica-35.pdf)).
10. S. A. IZAR, Funções de Morse e topologia das superfícies III: Campos pseudo-gradientes de uma função de Morse sobre uma superfície, *Métrica* no. 44 (1992), 1–22 (available at [www.ibilce.unesp.br/Home/Departamentos/Matematica/metrica-44.pdf](http://www.ibilce.unesp.br/Home/Departamentos/Matematica/metrica-44.pdf)).
11. W. L. MARAR AND J. J. NUÑO-BALLESTEROS, The doodle of a finitely determined map germ from  $\mathbb{R}^2$  to  $\mathbb{R}^3$ , *Adv. Math.* **221** (2009), 1281–1301.
12. J. W. MILNOR, *Morse theory*, Annals of Mathematics Studies, Volume 51 (Princeton University Press, 1963).
13. J. W. MILNOR, *Lectures on the H-cobordism theorem*, Mathematical Notes, Volume 1 (Princeton University Press, 1965).
14. J. A. MOYA-PÉREZ AND J. J. NUÑO-BALLESTEROS, The link of finitely determined map germ from  $\mathbb{R}^2$  to  $\mathbb{R}^2$ , *J. Math. Soc. Jpn* **62**(4) (2010), 1069–1092.
15. J. A. MOYA-PÉREZ AND J. J. NUÑO-BALLESTEROS, Topological classification of corank 1 map germs from  $\mathbb{R}^3$  to  $\mathbb{R}^3$ , *Rev. Mat. Complut.* **27**(2) (2014), 421–445.
16. J. A. MOYA-PÉREZ AND J. J. NUÑO-BALLESTEROS, Gauss words and the topology of map germs from  $\mathbb{R}^3$  to  $\mathbb{R}^3$ , *Rev. Mat. Ibero.* **31**(1) (2015), 977–988.

17. I. NAKAI, On topological types of polynomial mappings, *Topology* **23**(1) (1984), 45–66.
18. T. NISHIMURA, Topological types of finitely  $C^0$ - $\mathcal{K}$ -determined map germs, *Trans. Am. Math. Soc.* **312**(2) (1989), 621–639.
19. A. O. PRISHLYAK, Topological equivalence of smooth functions with isolated critical points on a closed surface, *Topol. Applic.* **119** (2002), 257–267.
20. G. REEB, Sur les points singuliers d’une forme de Pfaff complètement intégrable ou d’une fonction numérique, *C. R. Acad. Sci. Paris* **222** (1946), 847–849.
21. J. H. RIEGER AND M. A. S. RUAS, Classification of A-simple germs from  $k^n$  to  $k^2$ , *Compositio Math.* **79** (1991), 99–108.
22. V. V. SHARKO, Smooth and topological equivalence of functions on surfaces, *Ukrain. Math. J.* **55** (2003), 832–846.
23. R. THOM, Local topological properties of differentiable mappings, in *Differential analysis: papers presented at the Bombay colloquium, 7–14 January 1964*, Tata Institute of Fundamental Research Studies in Mathematics, Volume 2, pp. 191–202 (Oxford University Press, 1964).
24. C. T. C. WALL, Finite determinacy of smooth map-germs, *Bull. Lond. Math. Soc.* **13**(6) (1981), 481–539.